

## Parte externa termostático ducha emp. 1 salida ROADSTER ACCENT\_RA007300

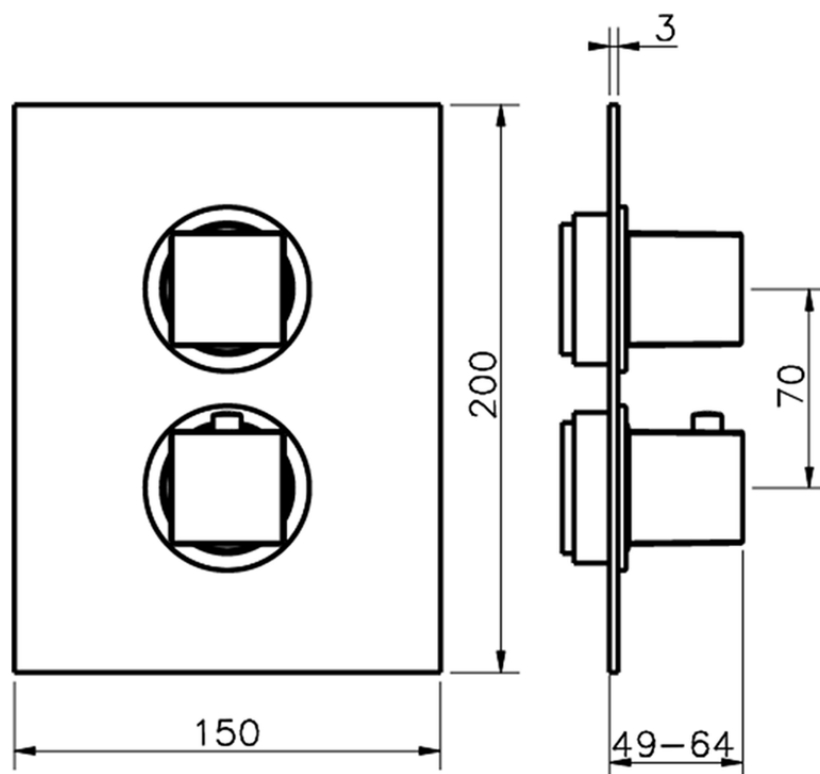

RA007300

<https://es.cisal.it/parte-externa-termostatico-ducha-emp-1-salida-roadster-accent-ra007300>



Piastra/Plate/Plaque/Platte/Placa  
 2-3mm: XX 25-40 YY 76-91  
 10mm: XX 16-31 YY 65-80

ZA007301

<https://es.cisal.it/parte-empotrada-termostatico-ducha-1-salida-empotrado-za007301>

2026-06-19