

Columna monomando ducha 2 funciones ARCANA ROYAL_AY004050

MODELO **AY004050**

Columna monomando ducha 2 funciones,desviador 2 salidas,columna telescópica,con soporte duchita fijo, duchita una función Arcana Ø53 mm,rociador redondo Ø 200 mm de Latón,flexible de Latón 150 cm



ACABADOS DISPONIBLES



21 21 Cromo



24 24 Oro



26 26 Cobre Viejo



27 27 Bronce Viejo



2A 2A Niquel Satinado Cepillado



74 74 Cromo/Oro

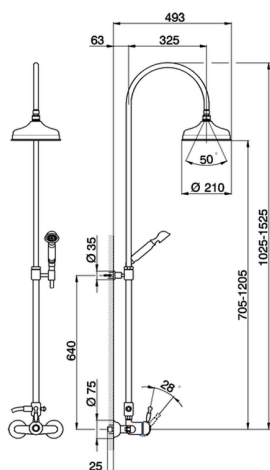

CARACTERÍSTICAS

Recambio Cartucho **ZZ92909000**

Cartucho Monomando 43 mm



Columna monomando ducha 2 funciones ARCANA ROYAL_AY004050

cisal

AY 00405 0

da Febbraio 2009 - from February 2009
ab Februar 2009 - de Février 2009

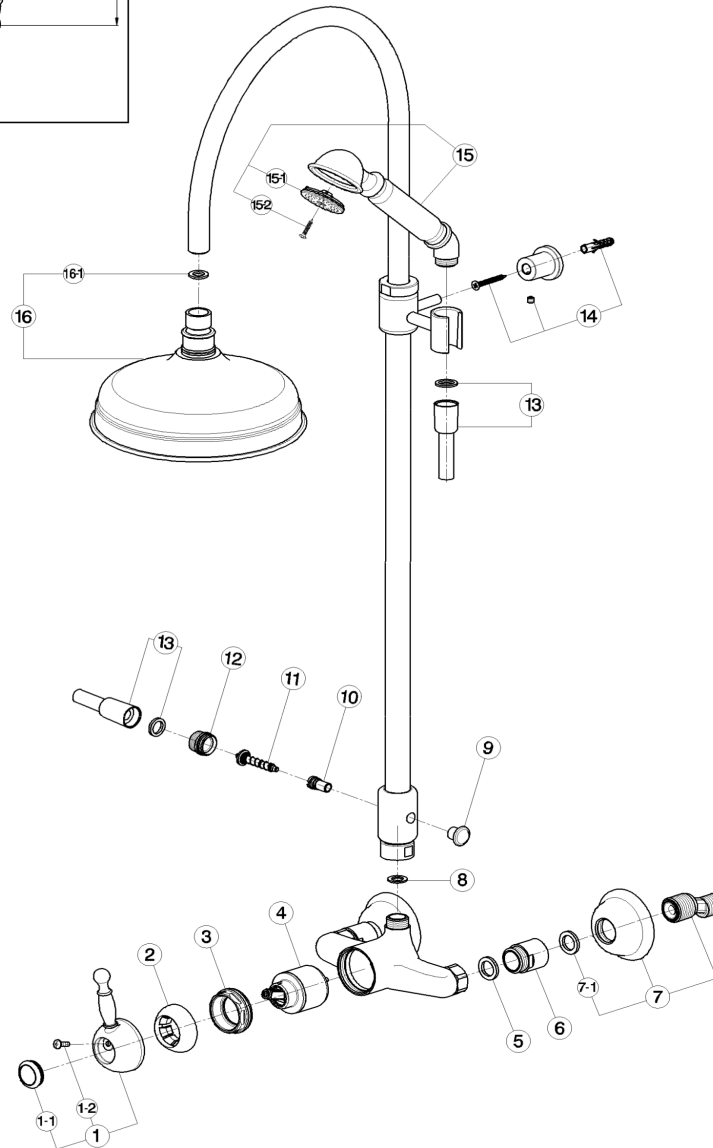
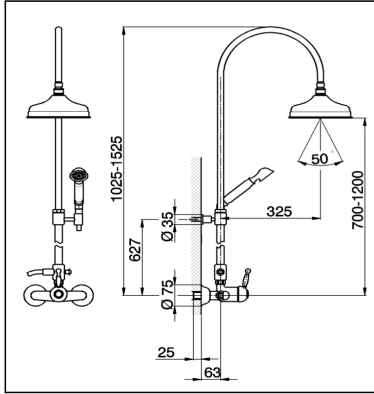

AY004050

<https://es.cisal.it/columna-monomando-ducha-2-funciones-arcana-royal-ay004050>

Columna monomando ducha 2 funciones ARCANA ROYAL_AY004050

cisal

AY 00405 0

 da Febbraio 2009 - from February 2009
 ab Februar 2009 - de Février 2009

NR.	DESCRIZIONE DESCRIPTION BESCREIBUNG DESCRIPTION	N.CODICE CODE NO. WERSKNR. NR.CODE	NR.	DESCRIZIONE DESCRIPTION BESCREIBUNG DESCRIPTION	N.CODICE CODE NO. WERSKNR. NR.CODE	NR.	DESCRIZIONE DESCRIPTION BESCREIBUNG DESCRIPTION	N.CODICE CODE NO. WERSKNR. NR.CODE
1	Leva monocomando AY Lever AY Hebel AY	ZZ903700	7	Eccentrico con rosone "AC" Excentrique + rosace "AC" Excentric connection with escutch."AC" S - Anschluss m.Rosette "AC"	ZZ928260	14	Set installazione asta doccia Set installation colonne de douche Installation set for sliding bar Installationsset für Wandstange	ZZ949870
1-1	Piacchetta per leva AY Plaquelette levier AY Cap for lever AY Abdeckkappe fuer Hebel AY	ZZ930480	7-1	Guarnizione NBR 90 SH. 24x16x2,7 Joint NBR 90 SH. 24x16x2,7 Gasket NBR 90 SH. 24x16x2,7 Dichtung NBR 90 SH. 24x16x2,7	ZZ926890	15	Doccia Arcana Douchette Arcana Arcana handshower Handbrause Arcana	DS014110
1-2	Vite M.4,5x15 tb.tc. Vis M.4,5x15 Screw M.4,5x15 Schraube M.4,5x15	ZZ926410	8	Guarnizione fibra 18,5x11x2 Joint en fibre 18,5x11x2 Gasket rubber 18,5x11x2 Fiberdichtung 18,5x11x2	ZZ927140	15-1	Vite di fissaggio diffusore per doccia Vis de fixation diffuseur pour douchette Fixing screw for spray kit handshower Befestigungsschraube fuer Einsatz	ZZ934010
2	Copricartuccia senza ideogrammi Couvre-cartouche sans ideogramme Escutcheon cartridge without ideogram Abdeckkappe ohne Ideogramm Calotta bloccaggio cartuccia piccola	ZZ927180	9	Pomolo per deviazione Pommeau pour inverseur Knob for diverter Zugknopf Umsteller	ZZ933940	15-2	Diffusore doccia AR Aérateur douche AR Aerator for showers AR Zerstaeuber fuer Brause AR Soffione doccia	ZZ905440
3	Ecrou pour cartouche Nut for mixing valve small Mutter fuer Kartusche	ZZ926030	10	Corpo deviazione automatica Corps inverseur automatique Body for aouthomatic diverter Körper für automatische Umstellung	ZZ949860	16	Pomme de douche Headshower Kopfbrause	DS016140
4	Cartuccia monocomando piccola Cartouche mitigeurs Mixing valve small size Kartusche	ZZ929090	11	Asta deviazione completa Tige inverseur complète Complete divertling rod Umstellung	ZZ933140	16-1	Guarnizione fibra 18,5x11x2 Joint en fibre 18,5x11x2 Gasket rubber 18,5x11x2 Fiberdichtung 18,5x11x2	ZZ927140
5	Guarnizione NBR 90 SH. 24x16x2,7 Joint NBR 90 SH. 24x16x2,7 Gasket NBR 90 SH. 24x16x2,7 Dichtung NBR 90 SH. 24x16x2,7	ZZ926890	12	Attacco flessibile Raccord flex Flexible connection Flex Anschluss	ZZ931410			
6	Prolunga per gruppo doccia Rallonge pour mélangeur douche Extension for shower mixer Verlängerungsset für Brausebatterie	ZZ946030	13	Flessibile D.14x150 1/2" conico x 1/2" Flexible D.14x150 avec raccord 1/2" Hose D.14x150 1/2"x1/2" Schlauch D.14x150 1/2" Konus x 1/2"	ZA009030			

AY004050

<https://es.cisal.it/columna-monomando-ducha-2-funciones-arcana-royal-ay004050>

2026-05-05