

Montura cerámica 1/2" DX 180° REPUESTOS_ZZ945890

MODELO **ZZ945890**

Montura cerámica 1/2" DX 180°, para termostático "H2"

ACABADOS DISPONIBLES



04 04 Sin acabado

CARACTERÍSTICAS

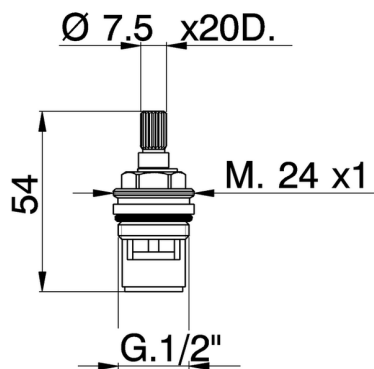

2026-06-15