

## Parte externa termostático ducha 3 funciones WELLNESS\_RI01V300

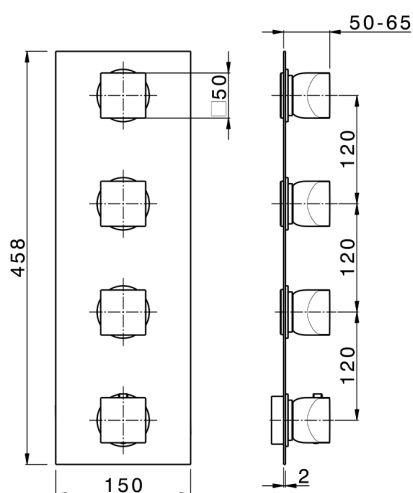

MODELO **RI01V300**

Parte externa termostático ducha 3 funciones, para art.ZA01V300

### ACABADOS DISPONIBLES

-  **21** 21 Cromo
-  **6X** 6X Blanco Mate/Oro Cepillado
-  **6V** 6V Blanco Mate/Niquel Cepillado
-  **5G** 5G Oro Rosa
-  **4Q** 4Q Blanco Mate
-  **40** 40 Negro Mate
-  **2W** 2W Oro Cepillado
-  **2F** 2F Niquel Cepillado
-  **24** 24 Oro
-  **7W** 7W Negro Mate/Oro Cepillado



### Termostático

El termostático Cisal es tu gestor personal del agua, ayudándote a manejar, controlar y ahorrar agua y energía.

### CARACTERÍSTICAS

Instalación  
Empotrado 1

**Empotrado**  
**ZA01V300**



## Parte empotrada termostático 3 funciones EMPOTRADO\_ZA01V300

MODELO **ZA01V300**

Parte empotrada termostático 3 funciones

ACABADOS DISPONIBLES



CARACTERÍSTICAS

Recambio Cartucho **23.51A.HF**

Empotrado **1**

**Cartucho Termostático HF**

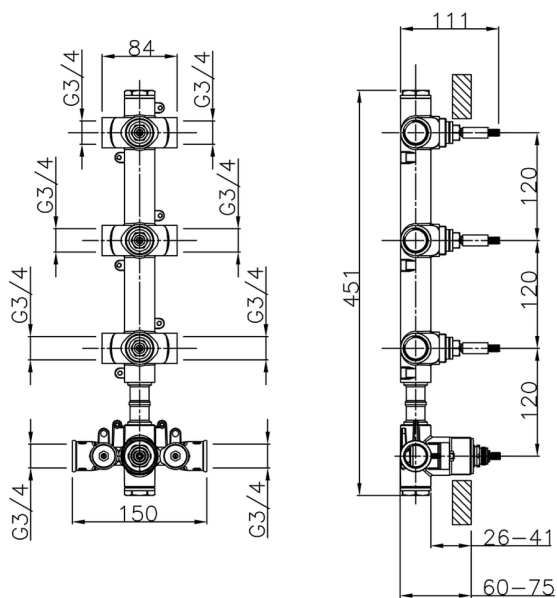

### Termostático

El termostático Cisal es tu gestor personal del agua, ayudándote a manejar, controlar y ahorrar agua y energía.



2025-01-15