

Palanca clínica monomando REPUESTOS_ZA005001

MODELO **ZA005001**

Palanca clínica monomando, para art. EL-BL

ACABADOS DISPONIBLES



CARACTERÍSTICAS

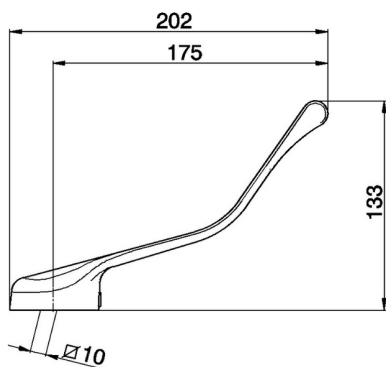

2026-05-01