

Parte empotrada llave de paso 3/4" EMPOTRADO_ZA003311

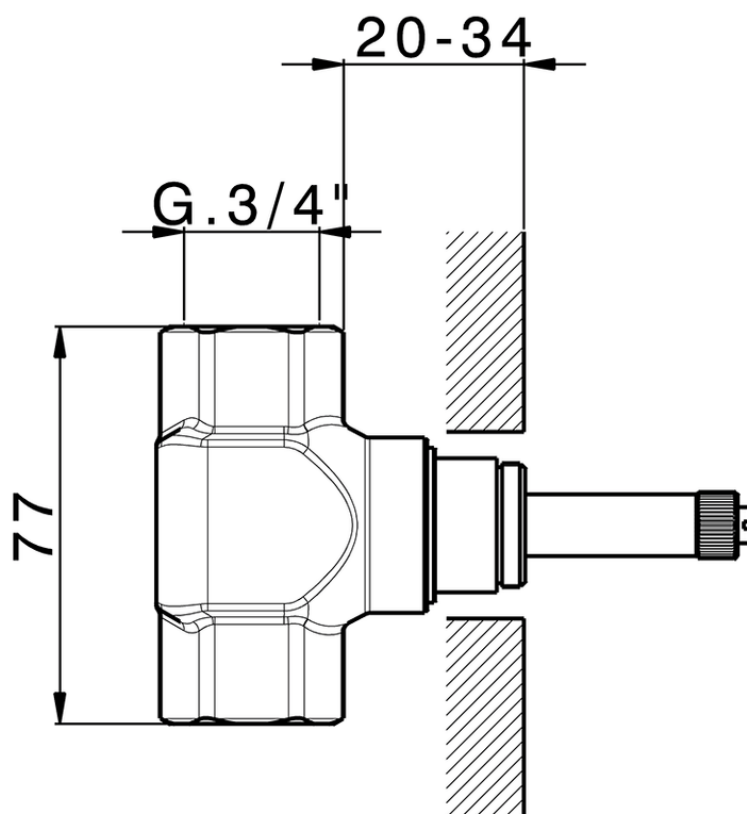

ZA003311

<https://es.cisal.it/parte-empotrada-llave-de-paso-3-4-empotrado-za003311>

2026-04-29