

Parte externa termostático ducha emp. 1 salida NUANCE X32_X1007300

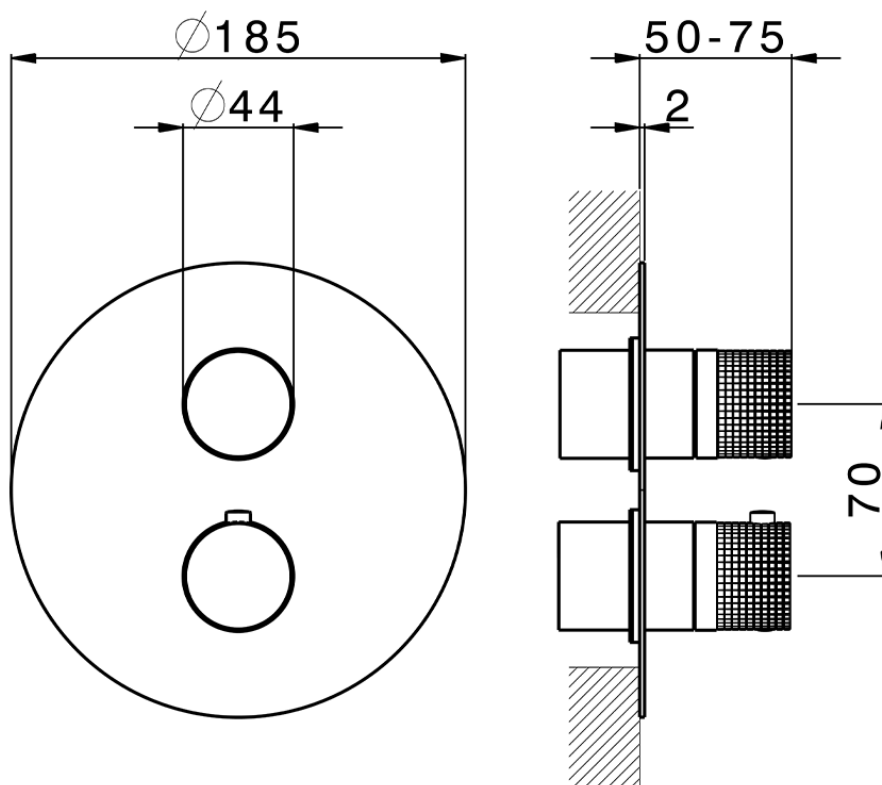

X1007300

<https://es.cisal.it/parte-externa-termostatico-ducha-emp-1-salida-nuance-x32-x1007300>



Piastra/Plate/Plaque/Platte/Placa
 2-3mm: XX 25-40 YY 76-91
 10mm: XX 16-31 YY 65-80

ZA007301

<https://es.cisal.it/parte-empotrada-termostatico-ducha-1-salida-empotrado-za007301>

2026-04-29