

Parte externa termostático ducha emp. 1 salida NUANCE X32_X1007300

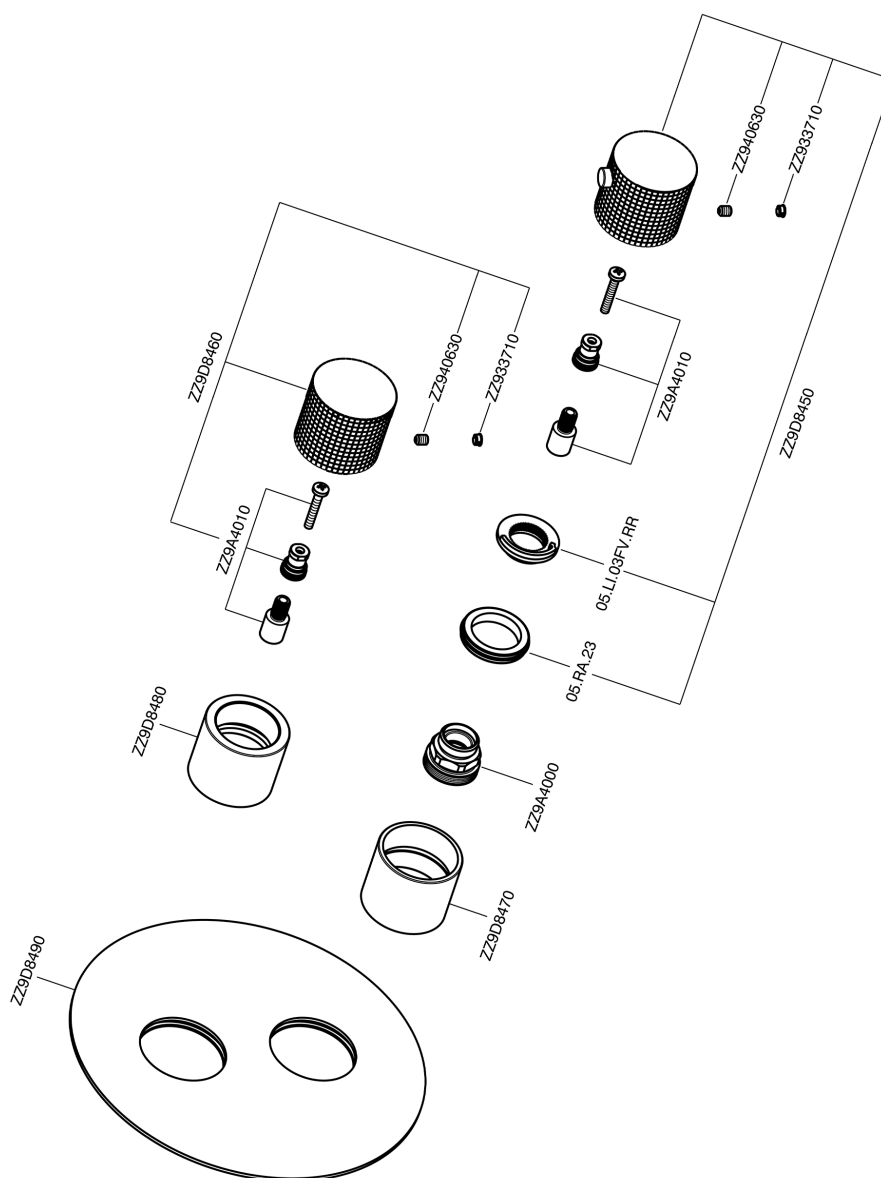

X1007300

<https://es.cisal.it/parte-externa-termostatico-ducha-emp-1-salida-nuance-x32-x1007300>

Parte empotrada termostático ducha 1 salida EMPOTRADO_ZA007301

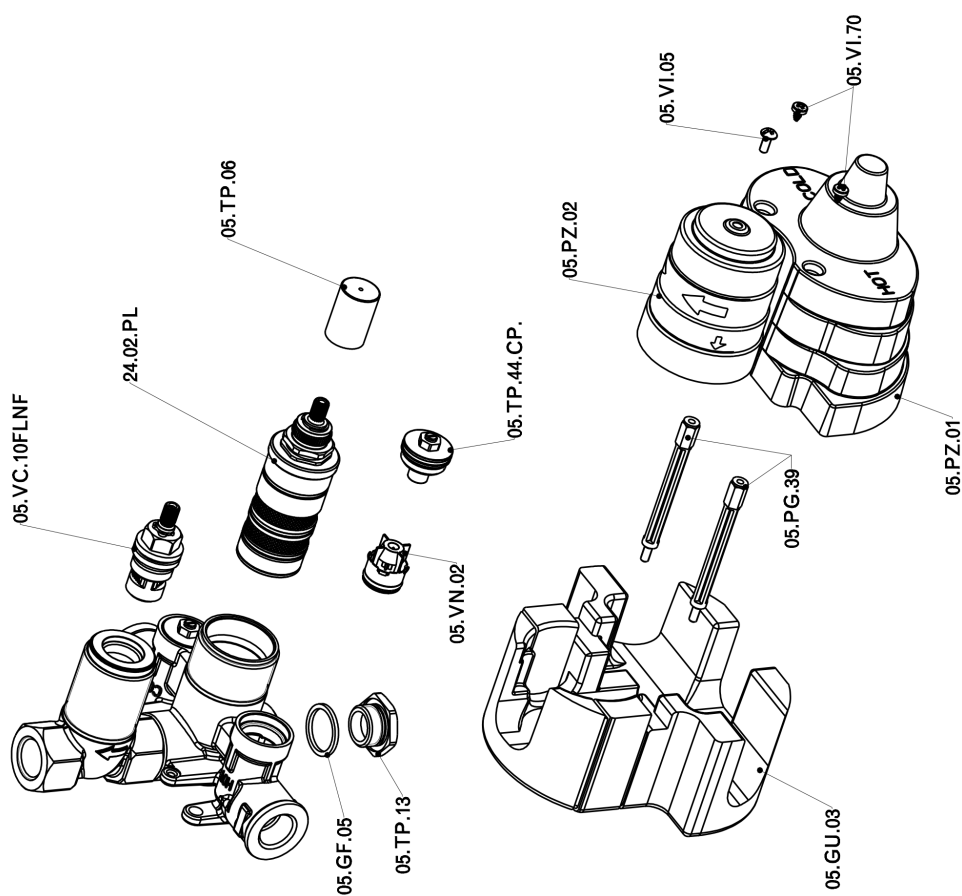

ZA007301

<https://es.cisal.it/parte-empotrada-termostatico-ducha-1-salida-empotrado-za007301>

2026-04-30