

Parte empotrada termostático ducha 3 salidas EMPOTRADO_ZA018201

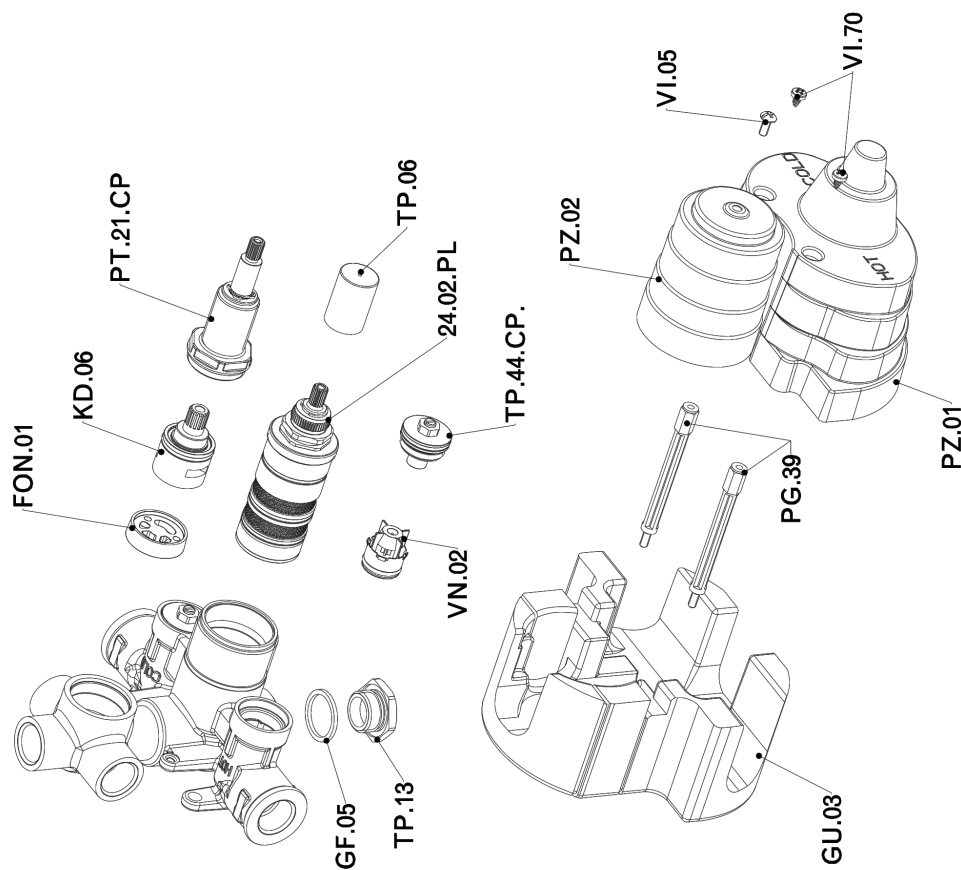

ZA018201

<https://es.cisal.it/parte-empotrada-termostatico-ducha-3-salidas-empotrado-za018201>

2026-06-14