

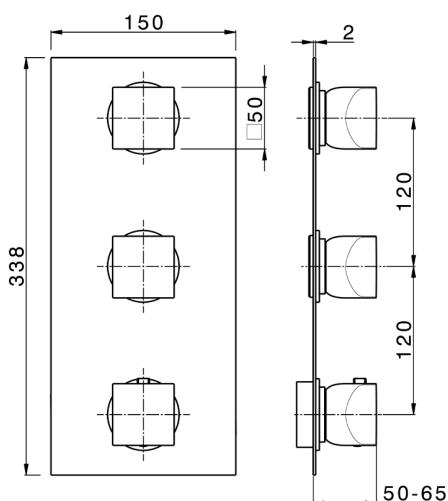



Parte externa termostático ducha 2 funciones WELLNESS_RI01V200



MODELO **RI01V200**

Parte externa termostático ducha 2 funciones, para art.ZA01V200

ACABADOS DISPONIBLES

-  **21** 21 Cromo
-  **24** 24 Oro
-  **6X** 6X Blanco Mate/Oro Cepillado
-  **6V** 6V Blanco Mate/Niquel Cepillado
-  **5G** 5G Oro Rosa
-  **4Q** 4Q Blanco Mate
-  **40** 40 Negro Mate
-  **2W** 2W Oro Cepillado
-  **2F** 2F Niquel Cepillado
-  **7W** 7W Negro Mate/Oro Cepillado



Termostático

El termostático Cisal es tu gestor personal del agua, ayudándote a manejar, controlar y ahorrar agua y energía.

CARACTERÍSTICAS

Instalación

Empotrado 1

Empotrado

ZA01V200



Parte empotrada termostático ducha 2 funciones EMPOTRADO_ZA01V200

MODELO **ZA01V200**

Parte empotrada termostático ducha 2 funciones

ACABADOS DISPONIBLES



CARACTERÍSTICAS

Recambio Cartucho **23.51A.HF**

Empotrado **1**

Cartucho Termostático HF



Termostático

El termostático Cisal es tu gestor personal del agua, ayudándote a manejar, controlar y ahorrar agua y energía.



2024-09-19