

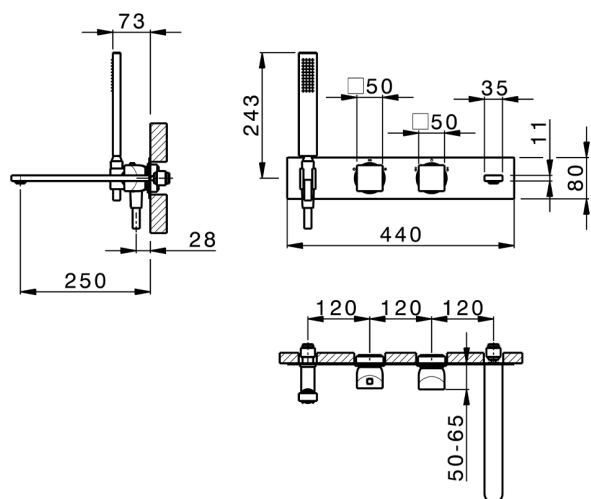

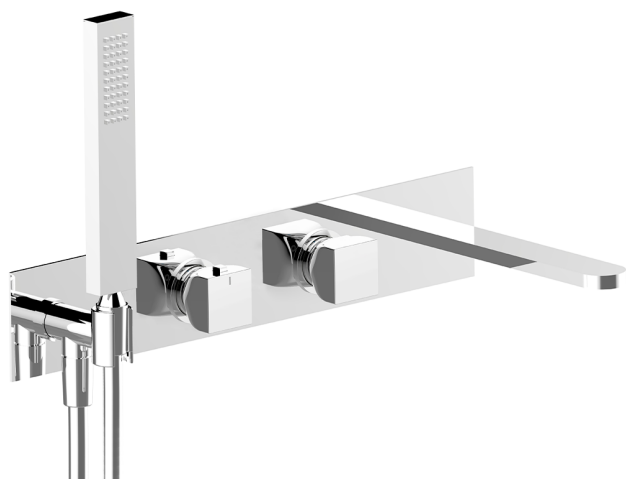







Parte externa termostático baño emp. 2 salidas HI-RISE_RI019440



MODELO **RI019440**

Parte externa termostático baño emp.2 salidas,con deviasstop 2 salidas,sin parte empotrada,para art.ZA019440

ACABADOS DISPONIBLES

-  **21** 21 Cromo
-  **24** 24 Oro
-  **2F** 2F Niquel Cepillado
-  **2W** 2W Oro Cepillado
-  **40** 40 Negro Mate
-  **4Q** 4Q Blanco Mate
-  **5G** 5G Oro Rosa
-  **6V** 6V Blanco Mate/Niquel Cepillado
-  **6X** 6X Blanco Mate/Oro Cepillado
-  **7W** 7W Negro Mate/Oro Cepillado



Termostático

El termostático Cisal es tu gestor personal del agua, ayudándote a manejar, controlar y ahorrar agua y energía.

CARACTERÍSTICAS

Instalación **Empotrado**
Empotrado 1 **ZA019440**



Parte empotrada termostático baño 2 salidas EMPOTRADO_ZA019440

MODELO **ZA019440**

Parte empotrada termostático baño 2 salidas, sin parte externa

ACABADOS DISPONIBLES

 **04** 04 Sin acabado

CARACTERÍSTICAS

Recambio Cartucho **24.04A.PP**

Empotrado **1**

Cartucho Termostático Plus P 8X20

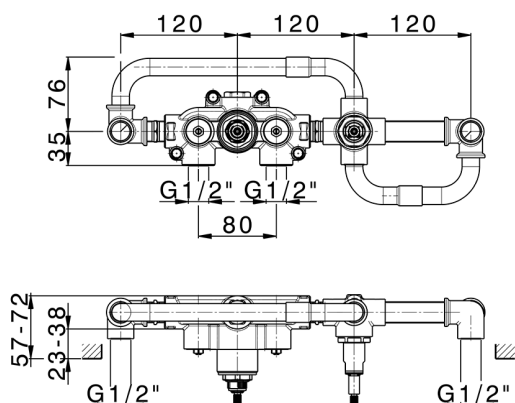

Termostático

El termostático Cisal es tu gestor personal del agua, ayudándote a manejar, controlar y ahorrar agua y energía.



2026-04-30