

## Parte externa monomando de suelo GRACE\_GC014510

MODELO **GC014510**

Parte externa monomando de suelo, sin parte empotrada, para art. ZA004510

### ACABADOS DISPONIBLES

-  **21** 21 Cromo
-  **2F** 2F Niquel Cepillado
-  **2W** 2W Oro Cepillado
-  **5H** 5H Dark Brass Brushed
-  **5L** 5L Brushed Black Titanium
-  **6T** 6T Cromo/Negro Mate

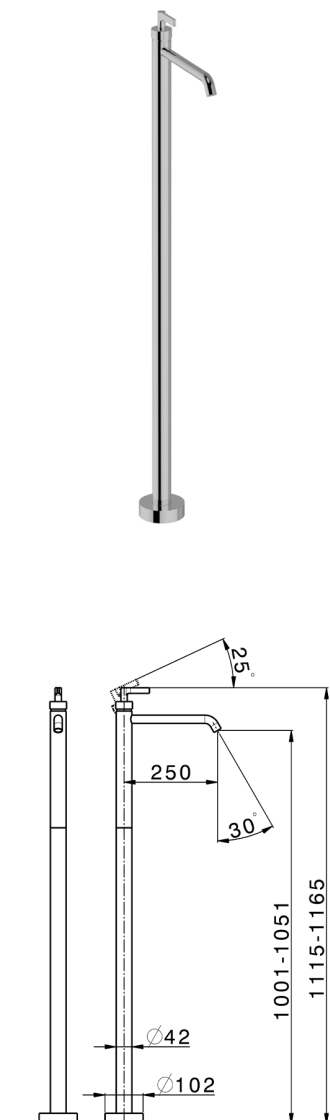

### CARACTERÍSTICAS

Recambio Cartucho **ZZ99672000**

**Cartucho Monomando 35 mm**

Instalación **Empotrado**

Empotrado 1 **ZA004510**



### EcoStop

La función EcoStop limita el caudal del agua aproximadamente el 50% de la salida máxima con una leve resistencia en la maneta. Basta con empujar ligeramente más allá de la mitad del tope sólo cuando se requiera la salida máxima de agua. Esto permitirá ahorrar hasta un 50% de agua.



## Parte empotrada monomando free-standing EMPOTRADO\_ZA004510

MODELO **ZA004510**

Parte empotrada monomando free-standing

ACABADOS DISPONIBLES

 **04** 04 Sin acabado

CARACTERÍSTICAS

Empotrado **1**

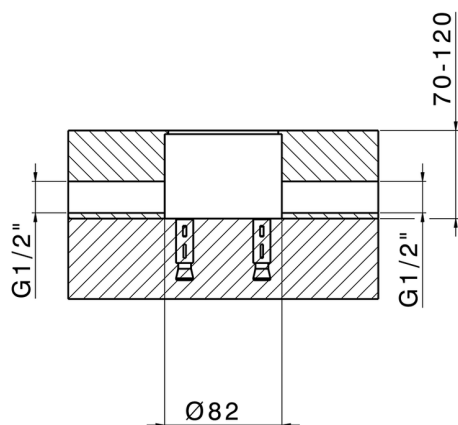

2026-01-29