





Parte externa termostático ducha empotrada SLIM_SM007200



MODELO **SM007200**

Parte externa termostático ducha empotrada, sin llave de paso, sin parte empotrada, para art. ZA007220

ACABADOS DISPONIBLES

-  **21** 21 Cromo
-  **2B** 2B Niquel Brillo
-  **40** 40 Negro Mate
-  **4Q** 4Q Blanco Mate

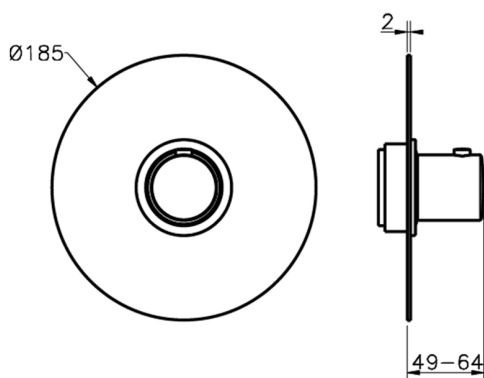

CARACTERÍSTICAS

Instalación	Empotrado
Empotrado 1	ZA007220



Termostático

El termostático Cisal es tu gestor personal del agua, ayudándote a manejar, controlar y ahorrar agua y energía.



Parte empotrada termostático 3/4" EMPOTRADO_ZA007220

MODELO **ZA007220**

Parte empotrada termostático 3/4", sin llave de paso, sin parte externa

ACABADOS DISPONIBLES



04 04 Sin acabado

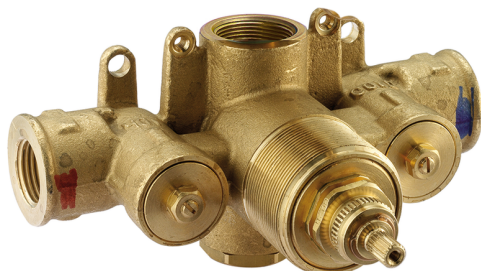

CARACTERÍSTICAS

Recambio Cartucho **23.51A.HF**

Empotrado **1**

Cartucho Termostático HF

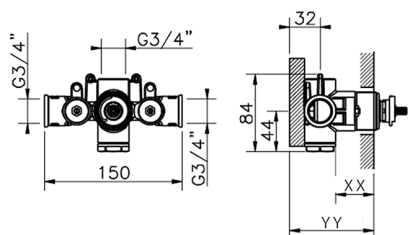

Piastra/Plate/Plaque/Platte/Placa

2-3mm: XX 25-40 YY 76-91

10mm: XX 16-31 YY 65-80



Termostático

El termostático Cisal es tu gestor personal del agua, ayudándote a manejar, controlar y ahorrar agua y energía.



2024-11-21