

Parte externa termostático ducha 2 funciones ROADSTER ACCENT_RA01R200

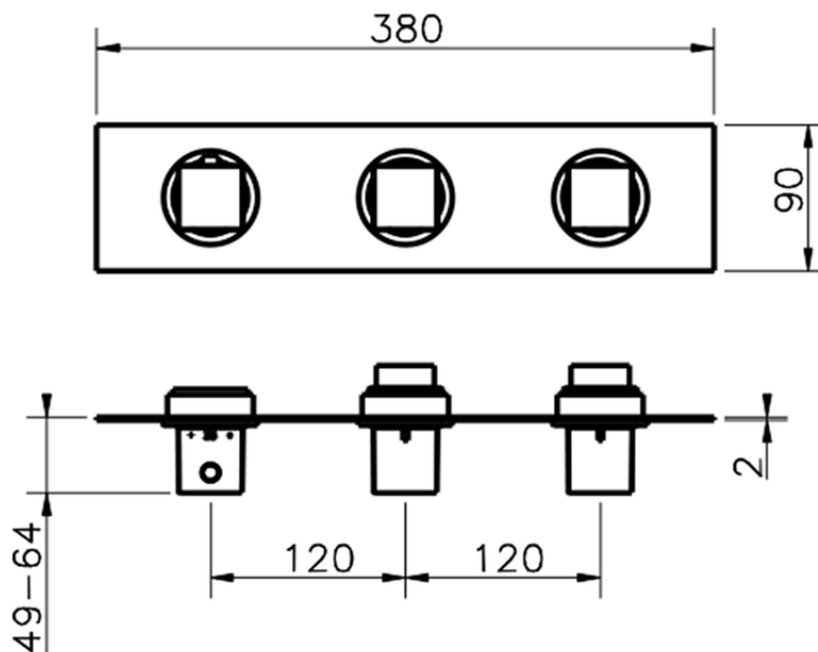

RA01R200

<https://es.cisal.it/parte-externa-termostatico-ducha-2-funciones-roadster-accent-ra01r200>

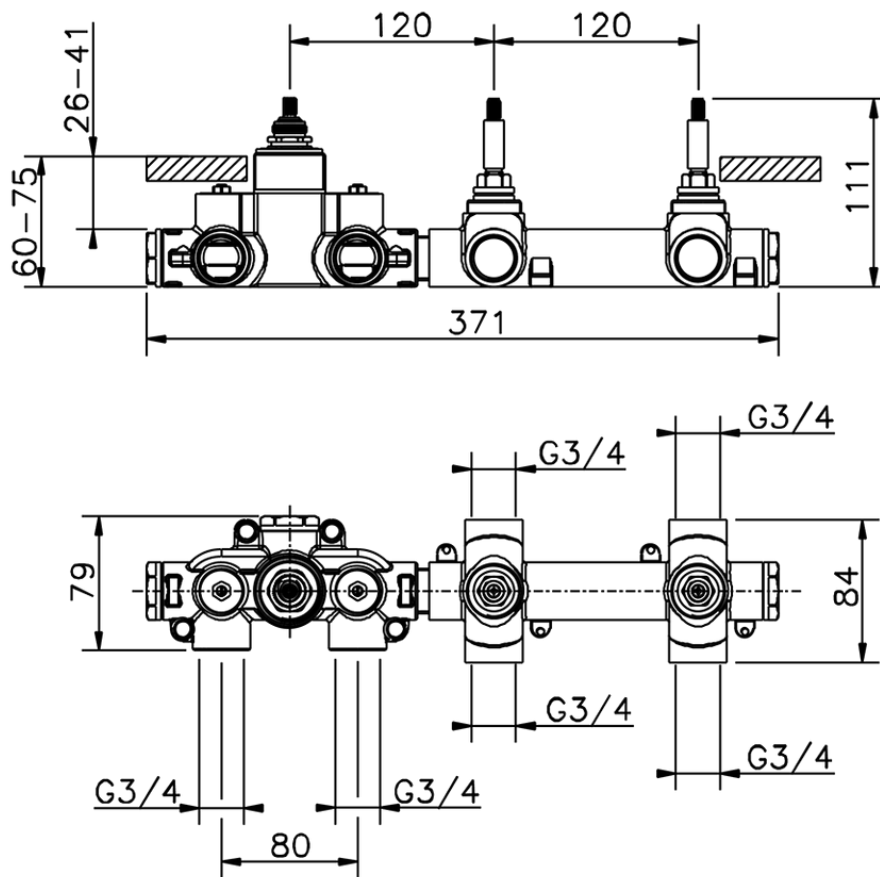

ZA01R200

<https://es.cisal.it/parte-empotrada-termostatico-ducha-2-funciones-empotrado-za01r200>

2024-11-21