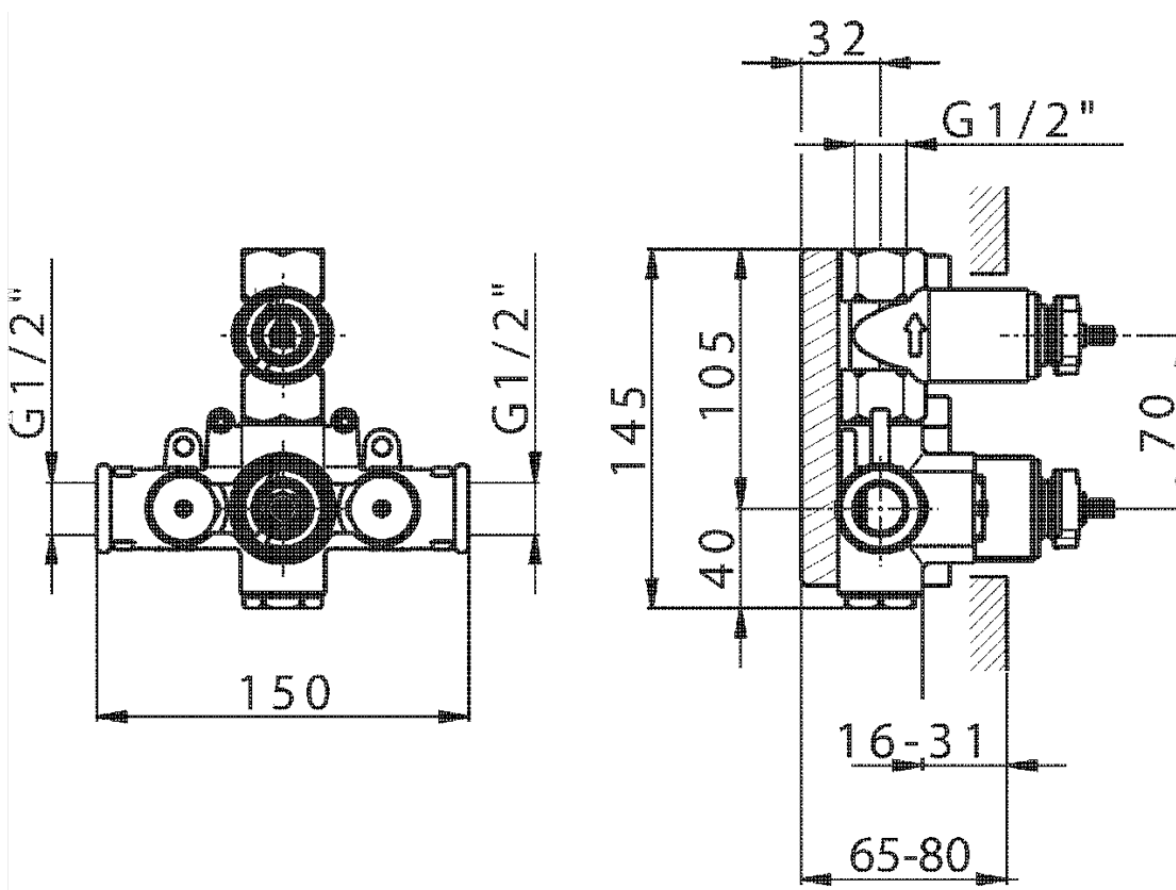

Parte empotrada termostático ducha 1 salida EMPOTRADO_ZA007281

ZA007281

<https://es.cisal.it/parte-empotrada-termostatico-ducha-1-salida-empotrado-za007281>

2025-01-05