

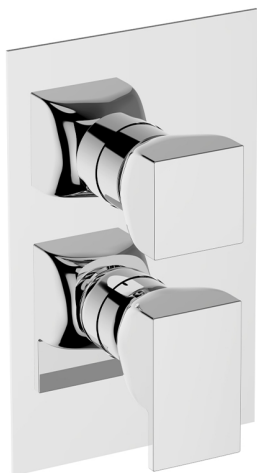









## Conjunto Monomando para One-Box ONE BOX\_RI0BM030



MODELO **RI0BM030**

Conjunto Monomando para One-Box, con desviador 2-3 salidas, profundidad mínima de instalación 67 mm, sin parte empotrada, para art. ZA00B030-ZA00B031

### ACABADOS DISPONIBLES

- 
**21** 21 Cromo
- 
**24** 24 Oro
- 
**2F** 2F Niquel Cepillado
- 
**2W** 2W Oro Cepillado
- 
**40** 40 Negro Mate
- 
**4Q** 4Q Blanco Mate
- 
**5G** 5G Oro Rosa
- 
**6V** 6V Blanco Mate/Niquel Cepillado
- 
**6X** 6X Blanco Mate/Oro Cepillado
- 
**7W** 7W Negro Mate/Oro Cepillado

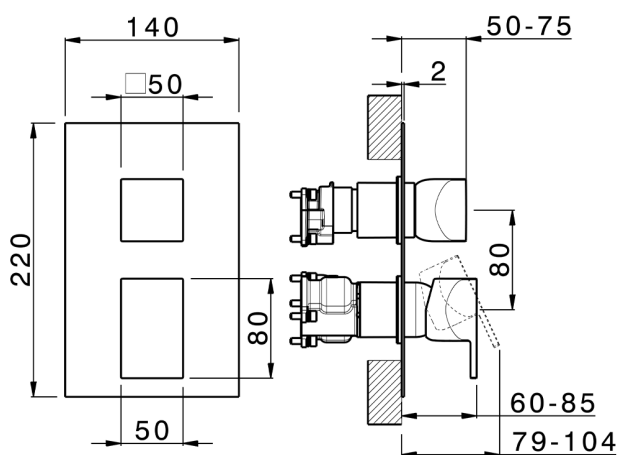

### CARACTERÍSTICAS

Recambio Cartucho **ZZ97179000**

**Cartucho Monomando 35 mm**

Instalación **Empotrado**

Empotrado 2

**ZA00B031**

**ZA00B030**



## One-Box Universal para empotrado ONE BOX\_ZA00B031



MODELO **ZA00B031**

One-Box Universal para empotrado, para termostático o monomando 1,2 o 3 salidas, sin parte externa, con silenciadores, con junta para sellado

ACABADOS DISPONIBLES

 **04** 04 Sin acabado

CARACTERÍSTICAS

Empotrado **1**



### Termostático

El termostático Cisal es tu gestor personal del agua, ayudándote a manejar, controlar y ahorrar agua y energía.



## One-Box Universal para empotrado ONE BOX\_ZA00B030



MODELO **ZA00B030**

One-Box Universal para empotrado, para termostático o monomando 1,2 o 3 salidas, sin parte externa, sin silenciadores, con junta para sellado

ACABADOS DISPONIBLES

 **04** 04 Sin acabado

CARACTERÍSTICAS

Empotrado **1**



### Termostático

El termostático Cisal es tu gestor personal del agua, ayudándote a manejar, controlar y ahorrar agua y energía.



2026-06-17