











Conjunto Monomando para One-Box ONE BOX_RI0BM030



MODELO **RI0BM030**

Conjunto Monomando para One-Box, con desviador 2-3 salidas, profundidad mínima de instalación 67 mm, sin parte empotrada, para art. ZA00B030-ZA00B031

ACABADOS DISPONIBLES

- 
21 21 Cromo
- 
24 24 Oro
- 
2F 2F Niquel Cepillado
- 
2W 2W Oro Cepillado
- 
40 40 Negro Mate
- 
4Q 4Q Blanco Mate
- 
5G 5G Oro Rosa
- 
6V 6V Blanco Mate/Niquel Cepillado
- 
6X 6X Blanco Mate/Oro Cepillado
- 
7W 7W Negro Mate/Oro Cepillado

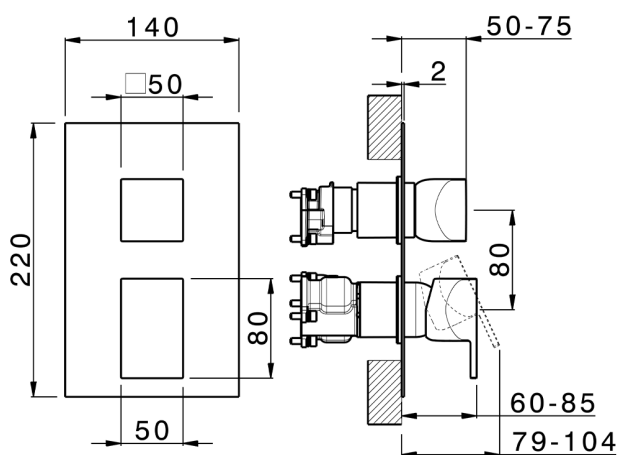

CARACTERÍSTICAS

Recambio Cartucho **ZZ97179000**

Cartucho Monomando 35 mm

Instalación **Empotrado**

Empotrado 2

ZA00B031

ZA00B030



One-Box Universal para empotrado ONE BOX_ZA00B031



MODELO **ZA00B031**

One-Box Universal para empotrado, para termostático o monomando 1,2 o 3 salidas, sin parte externa, con silenciadores, con junta para sellado

ACABADOS DISPONIBLES

 **04** 04 Sin acabado

CARACTERÍSTICAS

Empotrado **1**



Termostático

El termostático Cisal es tu gestor personal del agua, ayudándote a manejar, controlar y ahorrar agua y energía.



One-Box Universal para empotrado ONE BOX_ZA00B030



MODELO **ZA00B030**

One-Box Universal para empotrado, para termostático o monomando 1,2 o 3 salidas, sin parte externa, sin silenciadores, con junta para sellado

ACABADOS DISPONIBLES

 **04** 04 Sin acabado

CARACTERÍSTICAS

Empotrado **1**



Termostático

El termostático Cisal es tu gestor personal del agua, ayudándote a manejar, controlar y ahorrar agua y energía.



2026-06-19