

Bañera monomando empotrada XION_XI001101

MODELO **XI001101**

Bañera monomando empotrada, doble control separado, duchita una función minimalista, caño borde bañera, Inox AISI 316L

ACABADOS DISPONIBLES



D1 D1 Inox Cepillado

CARACTERÍSTICAS

Recambio Cartucho **ZZ96779000**

Cartucho Monomando 35 mm

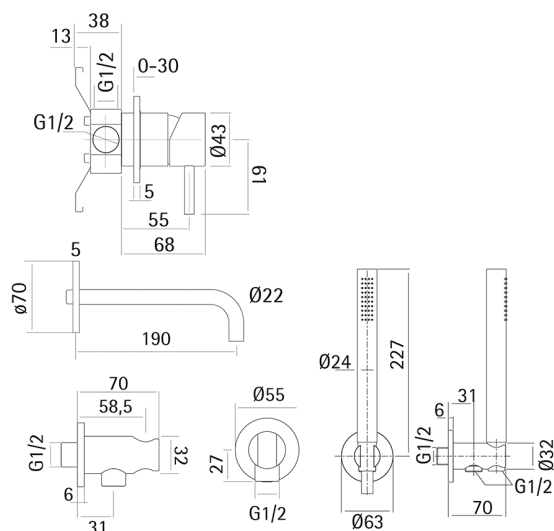

Bañera monomando empotrada XION_XI001101

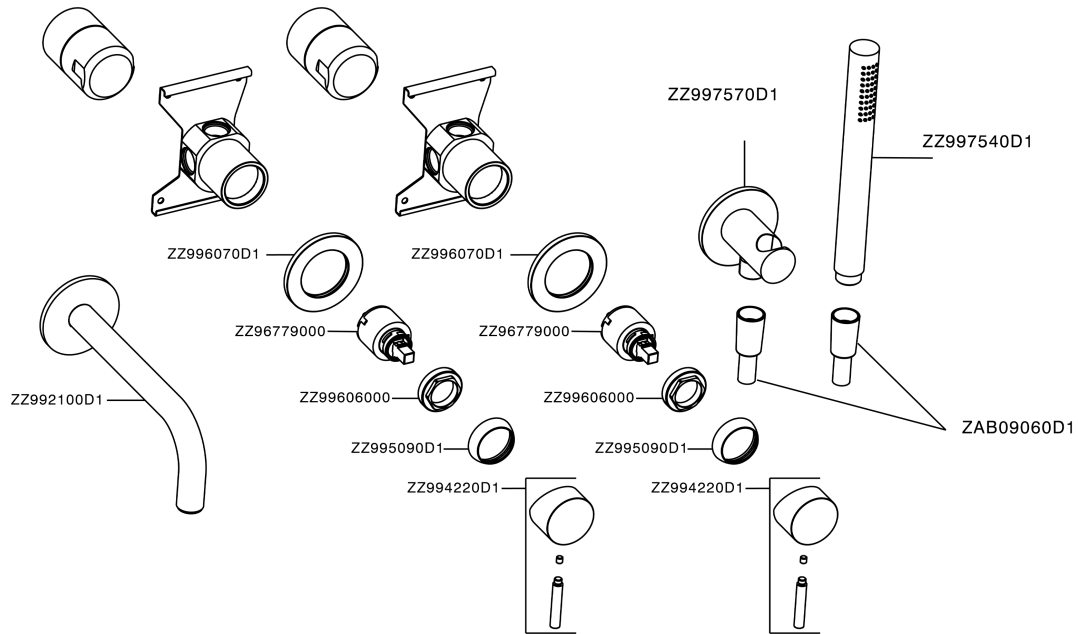

XI001101

<https://es.cisal.it/banera-monomando-empotrada-xion-xi001101>

2024-11-23