

## Alargador +25 mm COMPLEMENTOS\_ZA000441

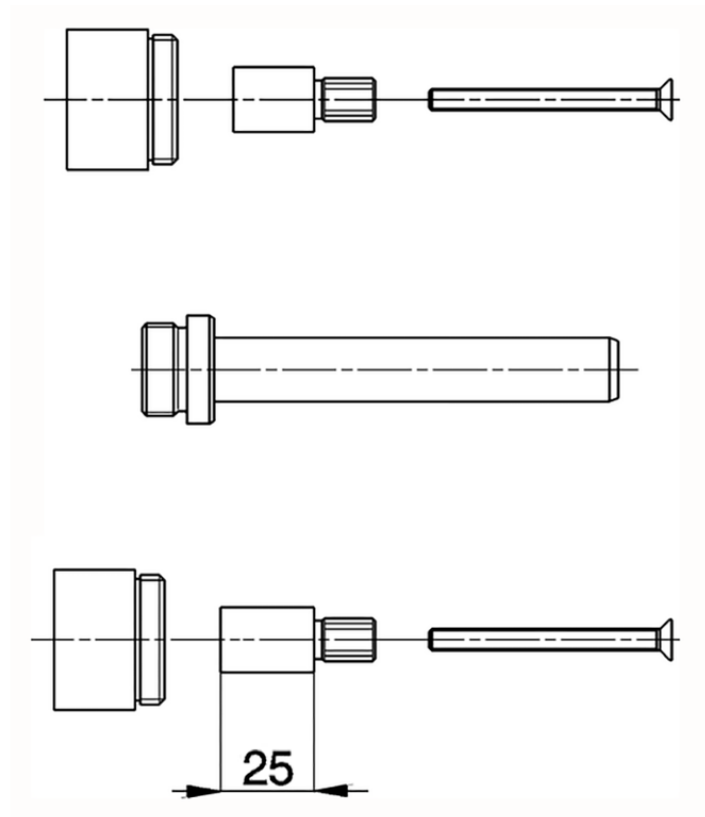

ZA000441

<https://es.cisal.it/alargador-25-mm-complementos-za000441>

2025-01-15