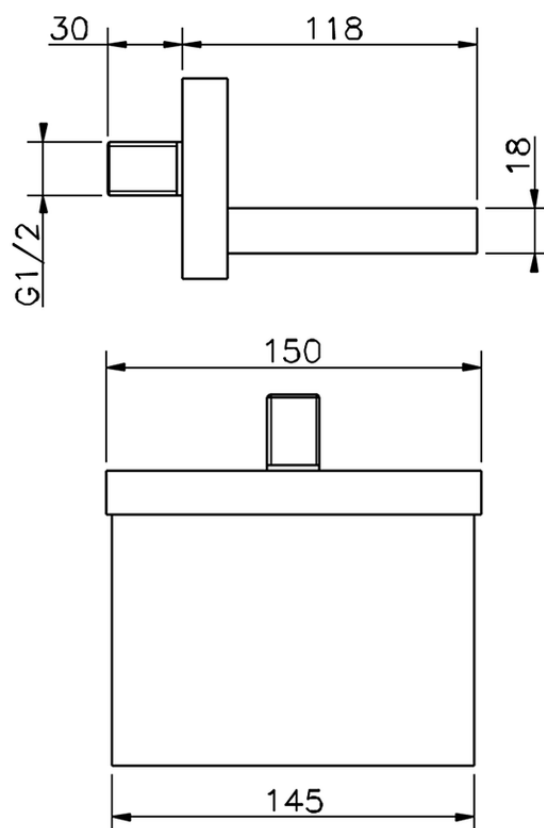

Caño de erogación COMPLEMENTOS_ZA002200

ZA002200

<https://es.cisal.it/cano-de-erogacion-complementos-za002200>

2024-11-23