

Parte externa lavabo de pared GRACE_GS013511

MODELO **GS013511**

Parte externa lavabo de pared, sin parte empotrada, para art. ZA033511

ACABADOS DISPONIBLES

-  **21** 21 Cromo
-  **2F** 2F Niquel Cepillado
-  **2W** 2W Oro Cepillado
-  **5H** 5H Dark Brass Brushed
-  **5L** 5L Brushed Black Titanium
-  **6T** 6T Cromo/Negro Mate

CARACTERÍSTICAS

Instalación	Empotrado
Empotrado 1	ZA033511

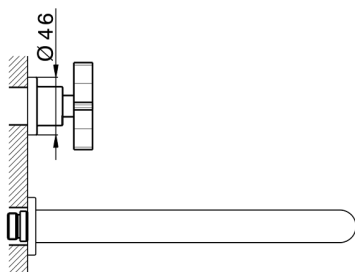
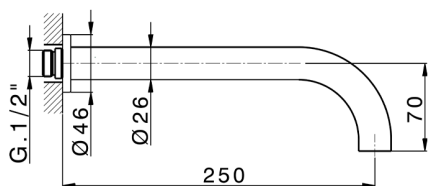

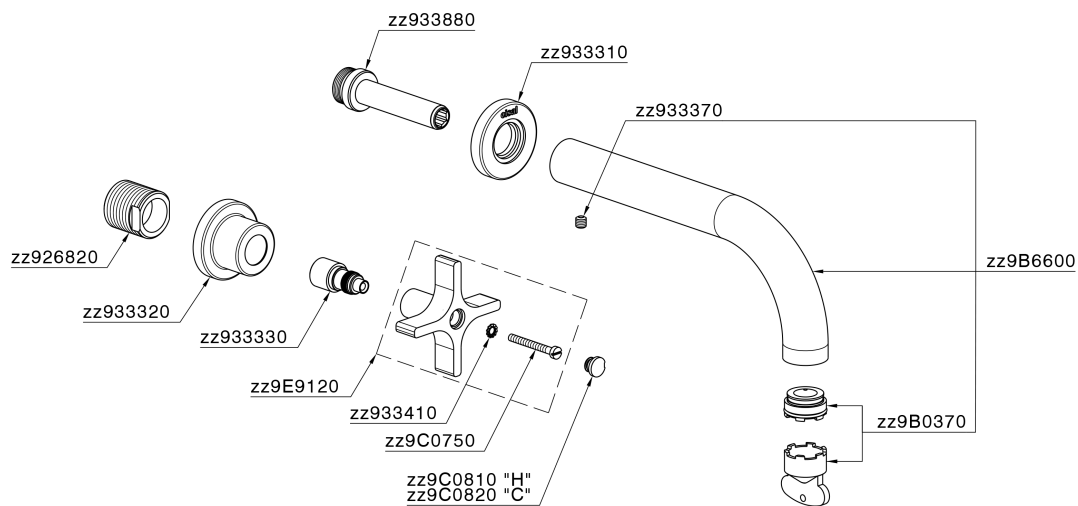
Parte externa lavabo de pared GRACE_GS013511

GS013511

<https://es.cisal.it/parte-externa-lavabo-de-pared-grace-gs013511>

Parte empotrada lavabo de pared EMPOTRADO_ZA033511

MODELO **ZA033511**

Parte empotrada lavabo de pared, con montura de derecha y montura de izquierda

ACABADOS DISPONIBLES



CARACTERÍSTICAS

Empotrado **1**



2026-04-30