

Parte empotrada termostático ducha 2 salidas EMPOTRADO_ZA019101

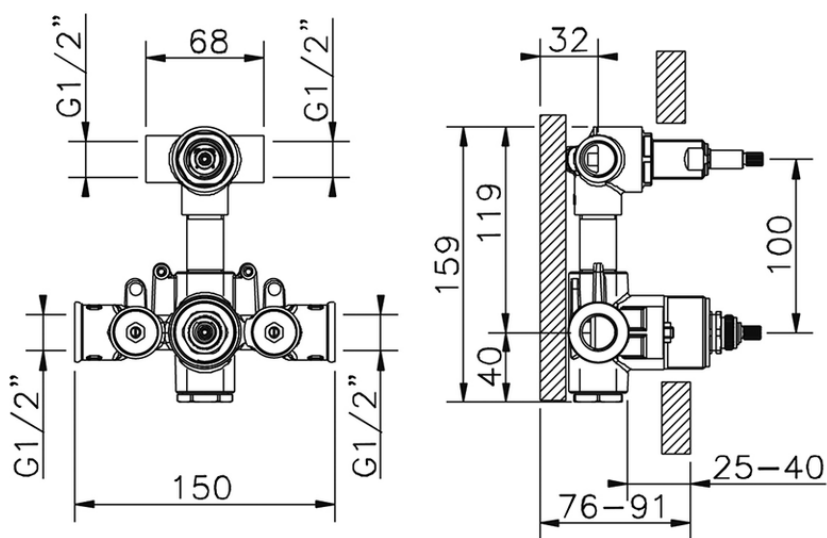

ZA019101

<https://es.cisal.it/parte-empotrada-termostatico-ducha-2-salidas-empotrado-za019101>

2024-12-04