





Parte externa termostático ducha emp. 1 salida NUANCE X32_X1007300

MODELO **X1007300**

Parte externa termostático ducha emp.1 salida,llave de paso,sin parte empotrada,para art.ZA007301,Inox AISI 316L

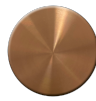
ACABADOS DISPONIBLES

-  **5H** 5H Dark Brass Brushed
-  **5L** 5L Brushed Black Titanium
-  **5N** 5N Oro Rosa Cepillado
-  **D1** D1 Inox Cepillado

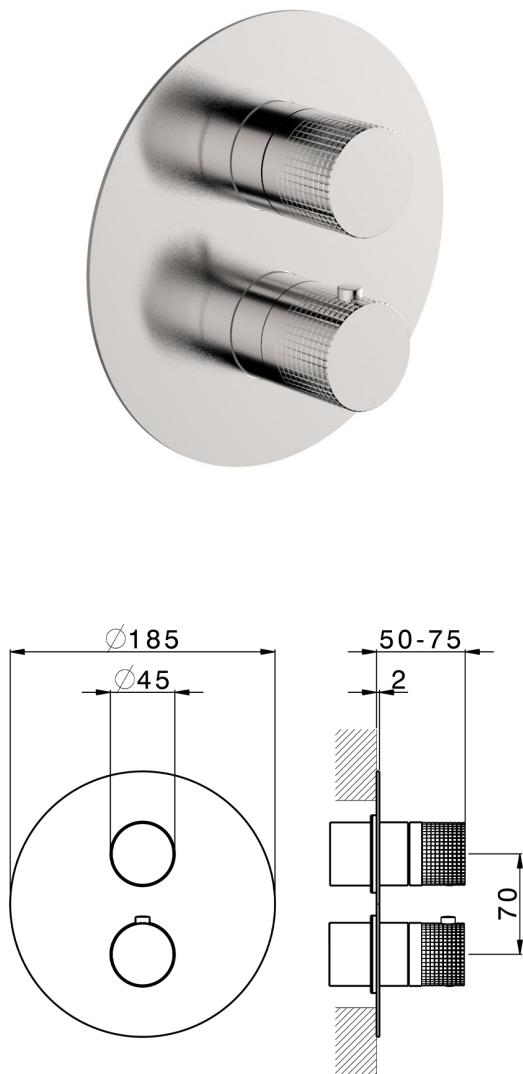

CARACTERÍSTICAS

Instalación **Empotrado**
Empotrado 1 **ZA007301**



Termostático

El termostático Cisal es tu gestor personal del agua, ayudándote a manejar, controlar y ahorrar agua y energía.



Parte externa termostático ducha emp. 1 salida NUANCE X32_X1007300

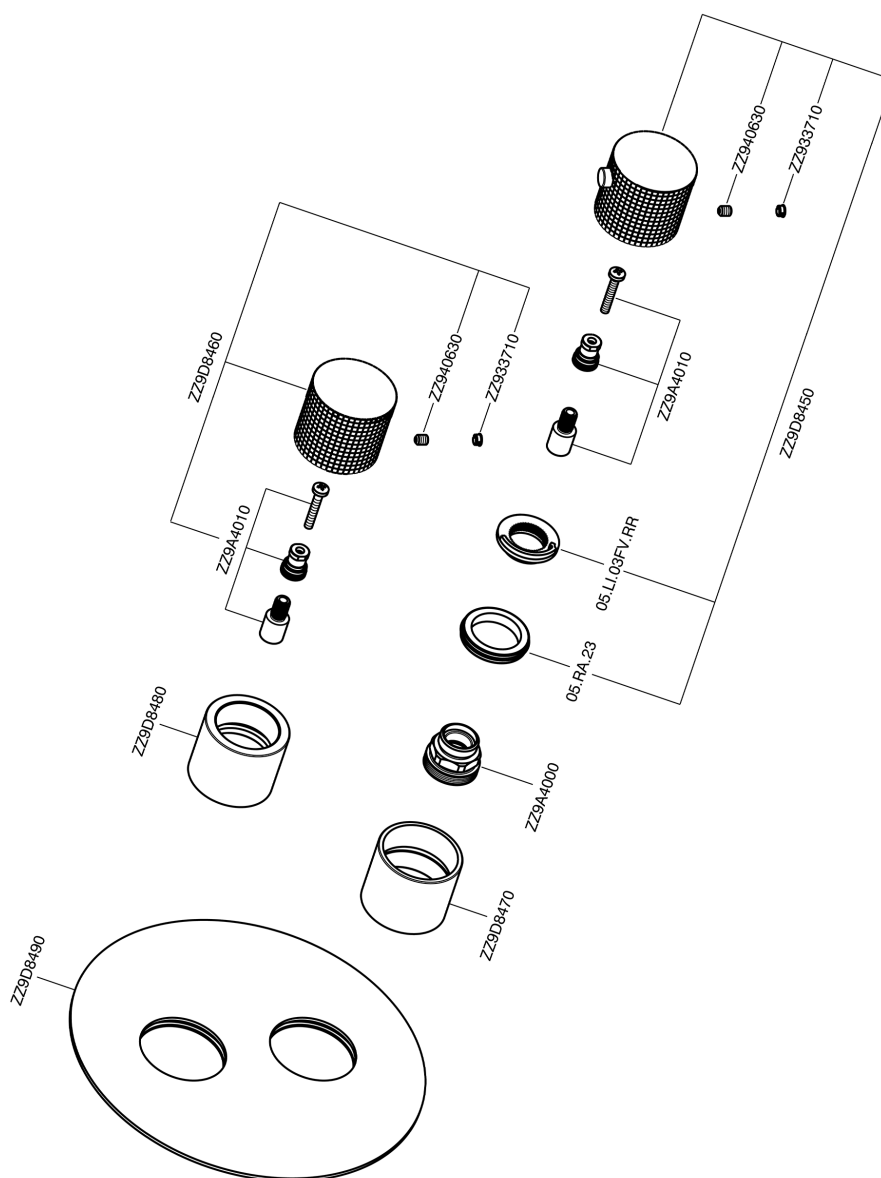

X1007300

<https://es.cisal.it/parte-externa-termostatico-ducha-emp-1-salida-nuance-x32-x1007300>

Parte empotrada termostático ducha 1 salida EMPOTRADO_ZA007301

MODELO **ZA007301**

Parte empotrada termostático ducha 1 salida, llave de paso con salida 1/2", sin parte externa

ACABADOS DISPONIBLES



04 04 Sin acabado



CARACTERÍSTICAS

Recambio Cartucho **24.04A.PP**

Empotrado **1**

Cartucho Termostático Plus P 8X20

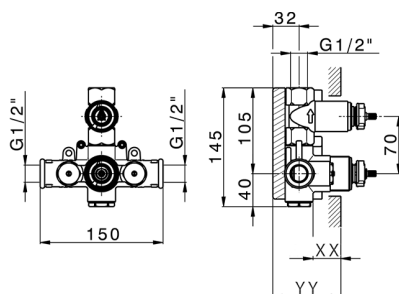

Piastra/Plate/Plaque/Platte/Placa

2-3mm: XX 25-40 YY 76-91

10mm: XX 16-31 YY 65-80



Termostático

El termostático Cisal es tu gestor personal del agua, ayudándote a manejar, controlar y ahorrar agua y energía.



2024-12-22