





Parte externa termostático ducha 3 funciones WELLNESS_LN01R300

MODELO **LN01R300**

Parte externa termostático ducha 3 funciones, para art.ZA01R300

ACABADOS DISPONIBLES

-  **21** 21 Cromo
-  **2F** 2F Níquel Cepillado
-  **40** 40 Negro Mate
-  **4Q** 4Q Blanco Mate

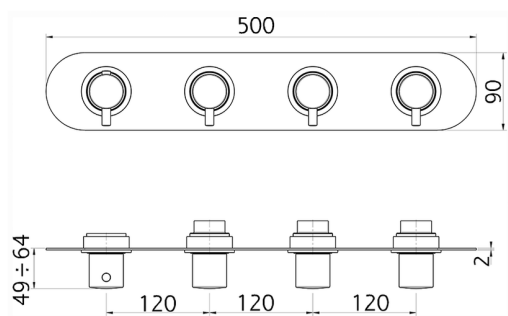
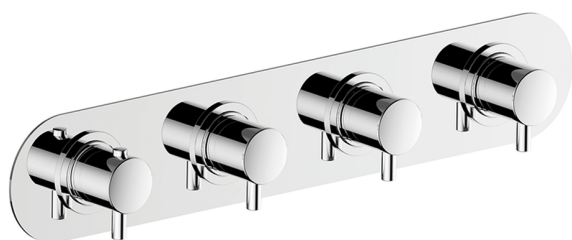

CARACTERÍSTICAS

Instalación **Empotrado**
Empotrado 1 **ZA01R300**



Termostático

El termostático Cisal es tu gestor personal del agua, ayudándote a manejar, controlar y ahorrar agua y energía.



Parte empotrada termostático 3 funciones EMPOTRADO_ZA01R300

MODELO **ZA01R300**

Parte empotrada termostático 3 funciones

ACABADOS DISPONIBLES

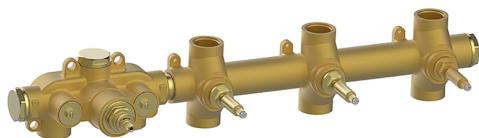

CARACTERÍSTICAS

Recambio Cartucho **23.51A.HF**

Empotrado **1**

Cartucho Termostático HF

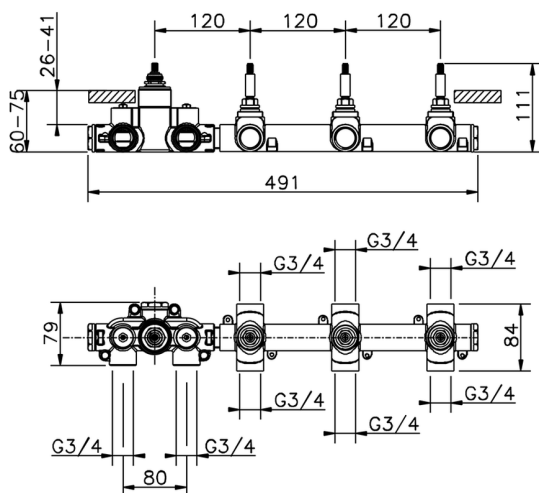

Termostático

El termostático Cisal es tu gestor personal del agua, ayudándote a manejar, controlar y ahorrar agua y energía.



2024-09-19