

Parte empotrada termostático 4 funciones PUSH&SHOWER_ZA0G64R0

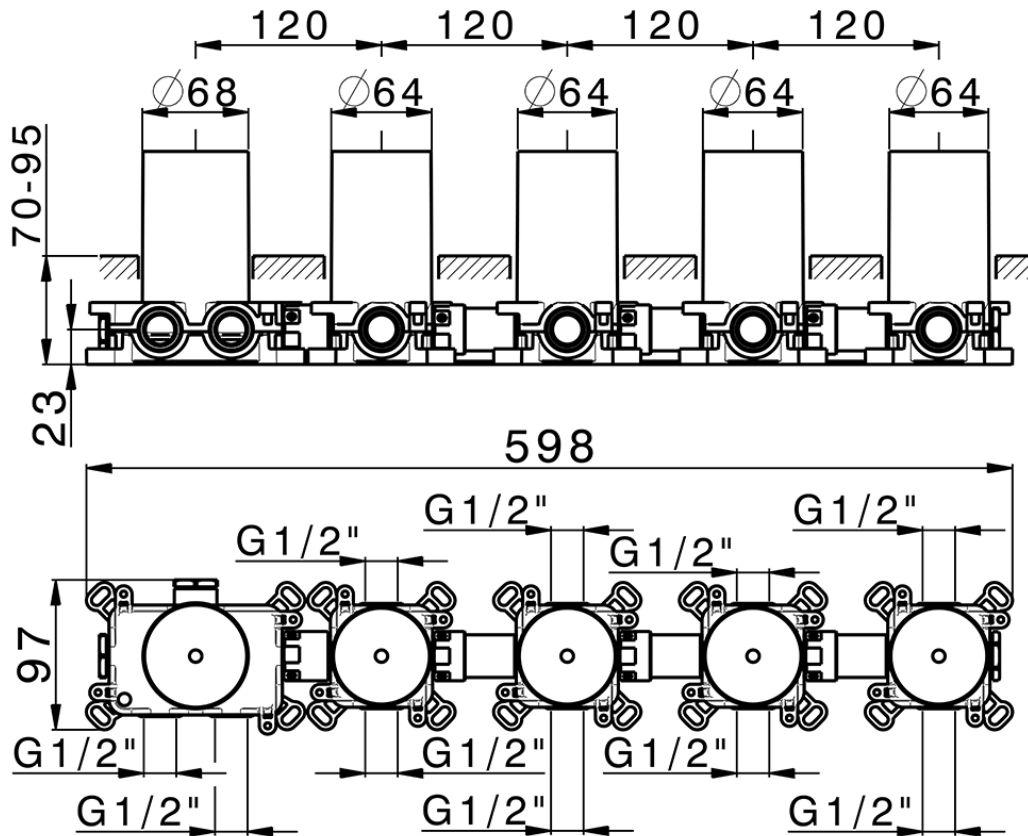

ZA0G64R0

<https://es.cisal.it/parte-empotrada-termostatico-4-funciones-pushshower-za0g64r0>

2026-06-15