

Caño de erogación WAVE_WA000240

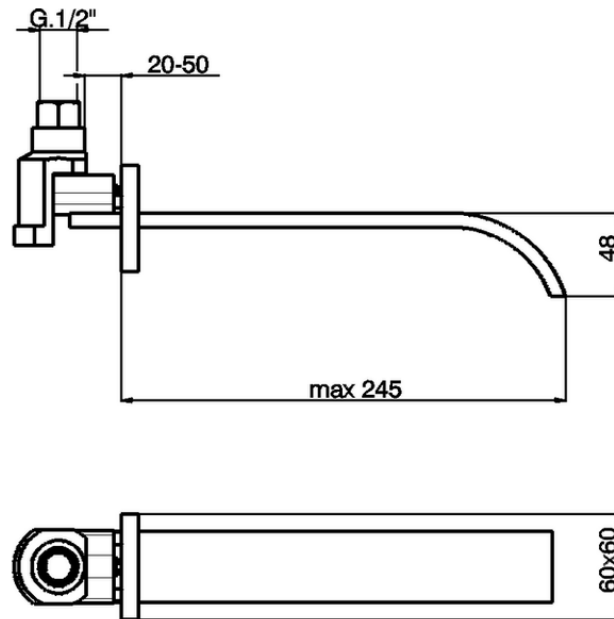

WA000240

<https://es.cisal.it/cano-de-erogacion-wave-wa000240>

2024-11-23