





Parte externa termostático ducha emp. 3 salidas LINEAVIVA_LV018200

MODELO **LV018200**

Parte externa termostático ducha emp.3 salidas, con devias top 3 salidas, sin parte empotrada, para art.ZA018201

ACABADOS DISPONIBLES

-  **21** 21 Cromo
-  **2B** 2B Níquel Brillo
-  **2F** 2F Níquel Cepillado
-  **40** 40 Negro Mate
-  **4Q** 4Q Blanco Mate

CARACTERÍSTICAS

Instalación **Empotrado**
Empotrado 1 **ZA018201**

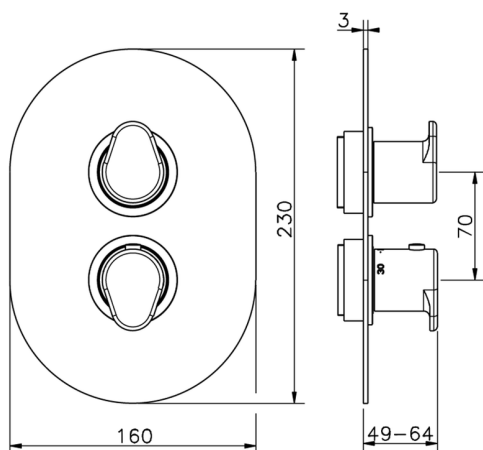

Termostático

El termostático Cisal es tu gestor personal del agua, ayudándote a manejar, controlar y ahorrar agua y energía.



Parte empotrada termostático ducha 3 salidas EMPOTRADO_ZA018201

MODELO **ZA018201**

Parte empotrada termostático ducha 3 salidas, con devia stop 3 salidas 1/2", sin parte externa



ACABADOS DISPONIBLES



04 04 Sin acabado

CARACTERÍSTICAS

Recambio Cartucho **24.04A.PP**

Empotrado **1**

Cartucho Termostático Plus P 8X20

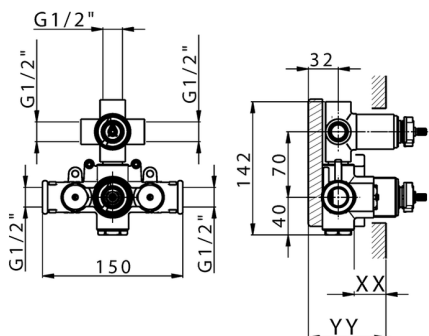

Piastra/Plate/Plaque/Platte/Placa

2-3mm: XX 25-40 YY 76-91

10 mm: XX 16-31 YY 65-80



DeviaStop

La tecnología Cisal DeviaStop le permite ajustar el caudal de agua y dirigirla hacia la salida elegida (rociador superior, ducha de mano, etc.).



Termostático

El termostático Cisal es tu gestor personal del agua, ayudándote a manejar, controlar y ahorrar agua y energía.



2024-12-22