





Conjunto Monomando para One-Box SMOOTH X32_X30BM010

MODELO **X30BM010**

Conjunto Monomando para One-Box, 1 salida - con maneta lisa, profundidad mínima de instalación 67 mm, sin parte empotrada - Inox AISI 316L, para art. ZA00B030-ZA00B031

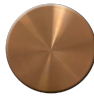
ACABADOS DISPONIBLES

-  **5H** 5H Dark Brass Brushed
-  **5L** 5L Brushed Black Titanium
-  **5N** 5N Oro Rosa Cepillado
-  **D1** D1 Inox Cepillado

CARACTERÍSTICAS

Recambio Cartucho **ZZ97179000**

Cartucho Monomando 35 mm

Instalación **Empotrado**

Empotrado 2 **ZA00B031**

ZA00B030

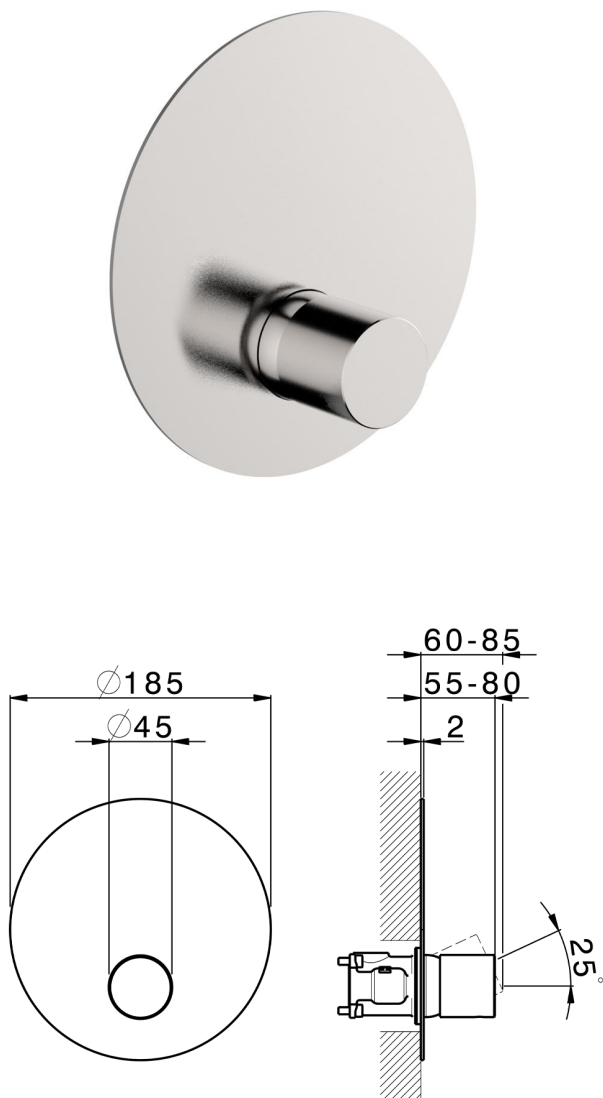

Conjunto Monomando para One-Box SMOOTH X32_X30BM010

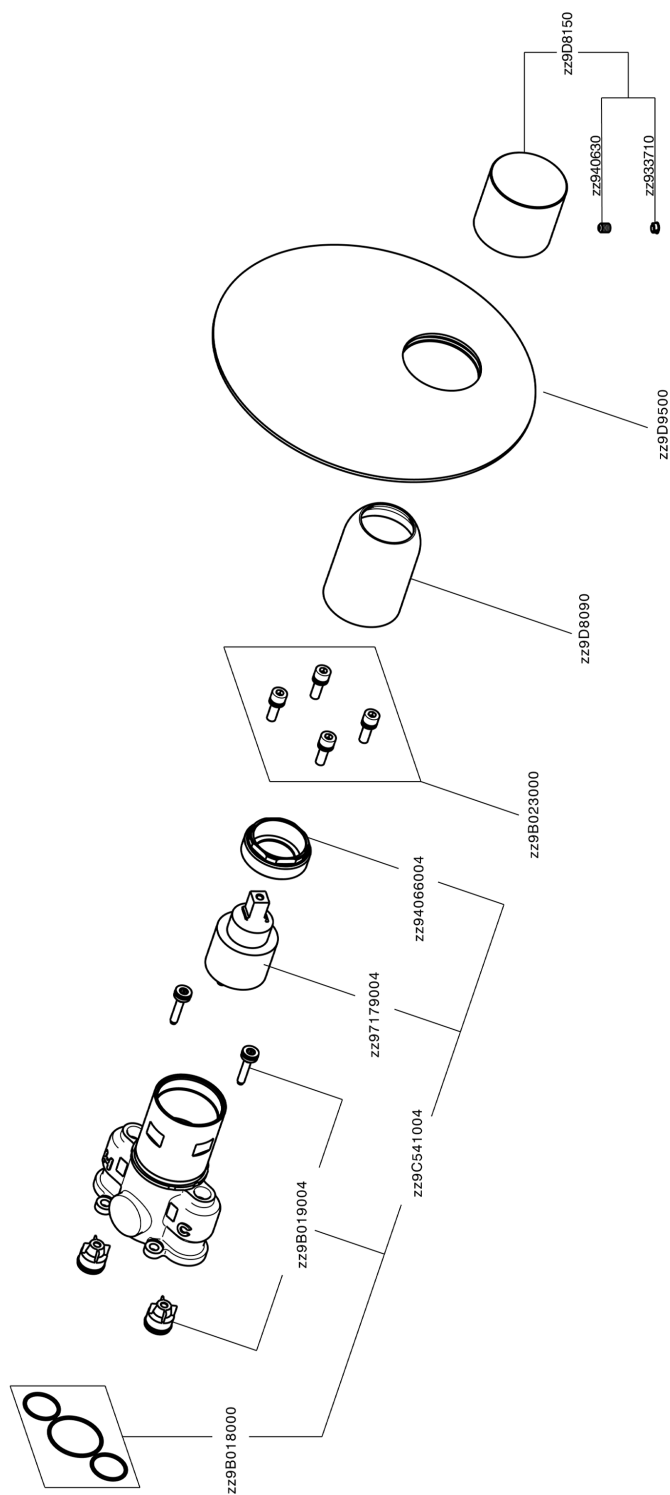

X30BM010

<https://es.cisal.it/conjunto-monomando-para-one-box-smooth-x32x30bm010>

One-Box Universal para empotrado ONE BOX_ZA00B031

MODELO **ZA00B031**

One-Box Universal para empotrado, para termostático o monomando 1,2 o 3 salidas, sin parte externa, con silenciadores, con junta para sellado

ACABADOS DISPONIBLES

 **04** 04 Sin acabado

CARACTERÍSTICAS

Empotrado **1**



Termostático

El termostático Cisal es tu gestor personal del agua, ayudándote a manejar, controlar y ahorrar agua y energía.



One-Box Universal para empotrado ONE BOX_ZA00B030



MODELO **ZA00B030**

One-Box Universal para empotrado, para termostático o monomando 1,2 o 3 salidas, sin parte externa, sin silenciadores, con junta para sellado

ACABADOS DISPONIBLES

 **04** 04 Sin acabado

CARACTERÍSTICAS

Empotrado **1**



Termostático

El termostático Cisal es tu gestor personal del agua, ayudándote a manejar, controlar y ahorrar agua y energía.



2024-09-16