

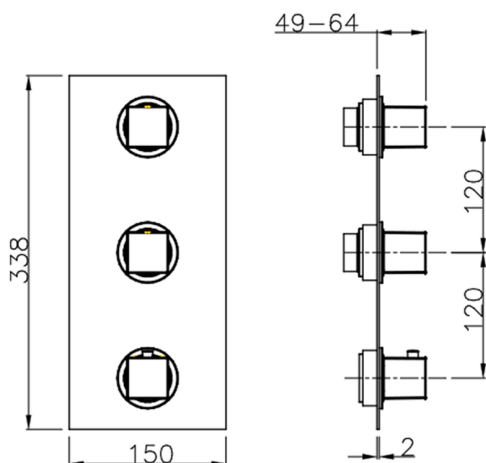





## Parte externa termostático ducha 2 funciones WELLNESS\_RA01V200



MODELO **RA01V200**

Parte externa termostático ducha 2 funciones, para art.ZA01V200

### ACABADOS DISPONIBLES

-  **21** 21 Cromo
-  **2B** 2B Niquel Brillo
-  **2F** 2F Niquel Cepillado
-  **2Q** 2Q Black Titanium
-  **40** 40 Negro Mate
-  **4Q** 4Q Blanco Mate

### CARACTERÍSTICAS

Instalación	<b>Empotrado</b>
Empotrado 1	<b>ZA01V200</b>



### Termostático

El termostático Cisal es tu gestor personal del agua, ayudándote a manejar, controlar y ahorrar agua y energía.



## Parte empotrada termostático ducha 2 funciones EMPOTRADO\_ZA01V200

MODELO **ZA01V200**

Parte empotrada termostático ducha 2 funciones

ACABADOS DISPONIBLES



CARACTERÍSTICAS

Recambio Cartucho **23.51A.HF**

Empotrado **1**

**Cartucho Termostático HF**

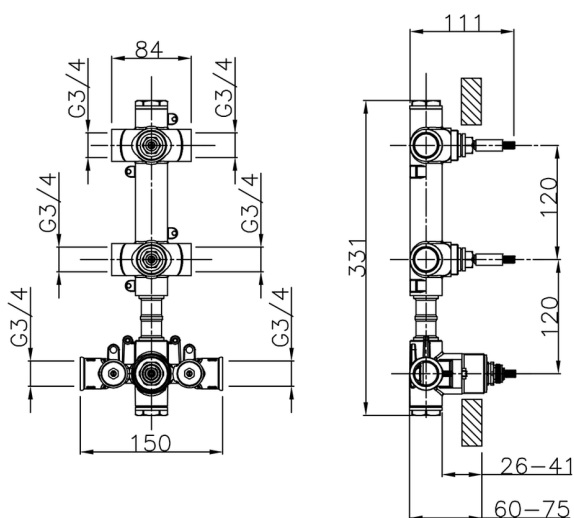

### Termostático

El termostático Cisal es tu gestor personal del agua, ayudándote a manejar, controlar y ahorrar agua y energía.



2024-09-19