

Parte externa llave de paso CHERIE_CF003310

CF003310

<https://es.cisal.it/parte-externa-llave-de-paso-cherie-cf003310>

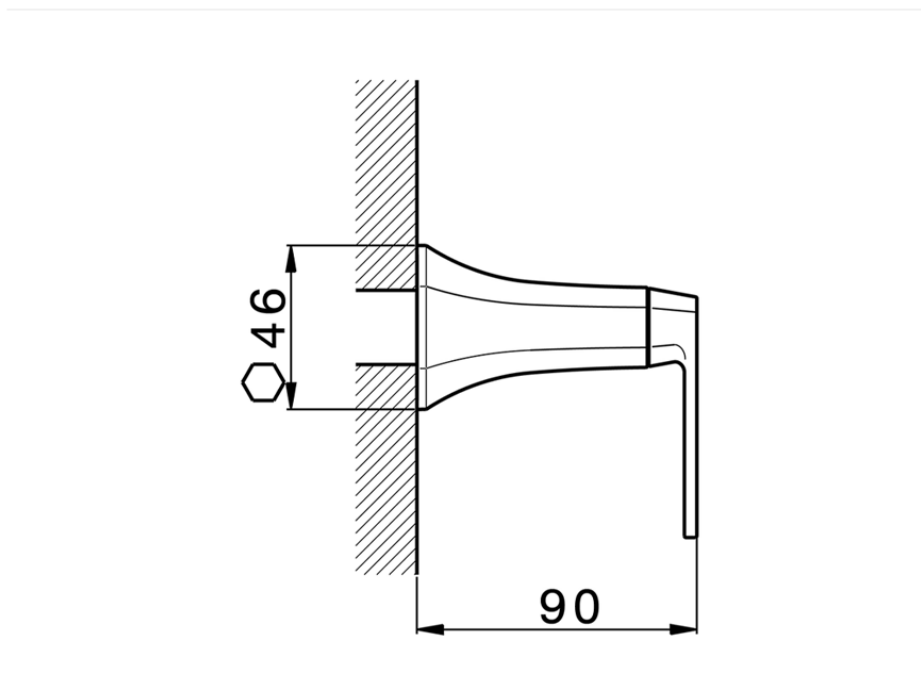
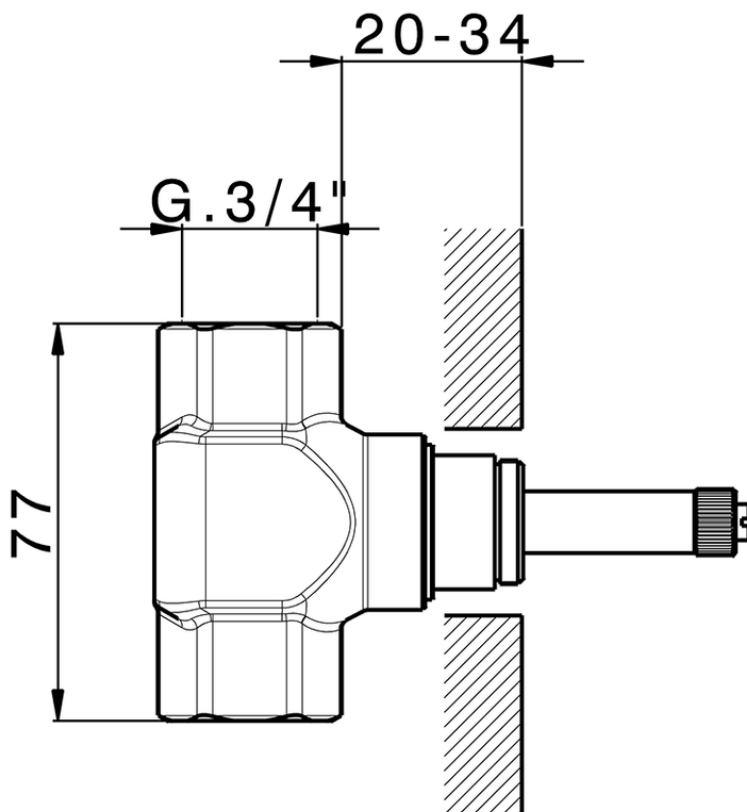

ZA003311

<https://es.cisal.it/parte-empotrada-llave-de-paso-3-4-empotrado-za003311>

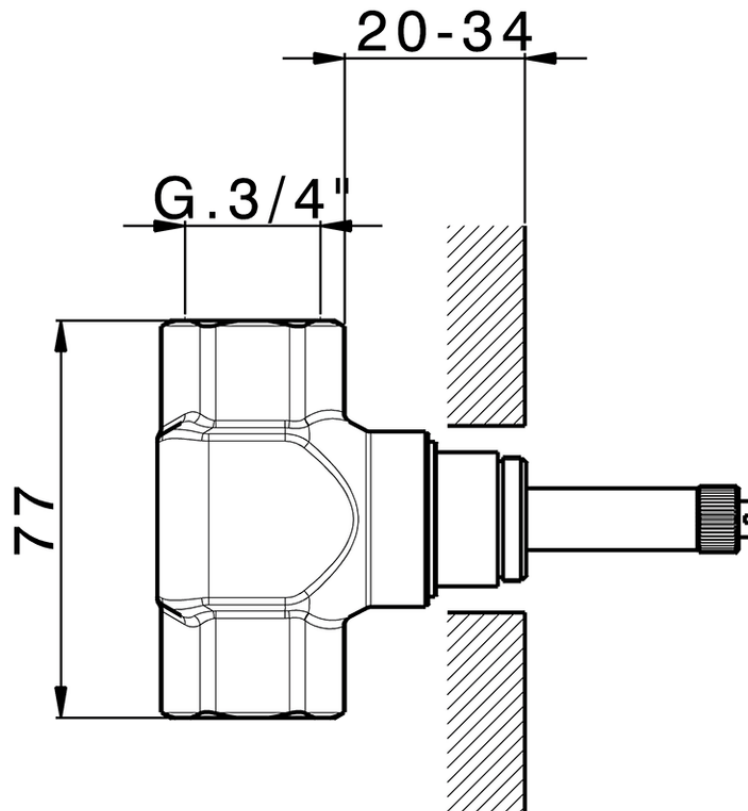

ZA003310

<https://es.cisal.it/parte-empotrada-llave-de-paso-3-4-empotrado-za003310>

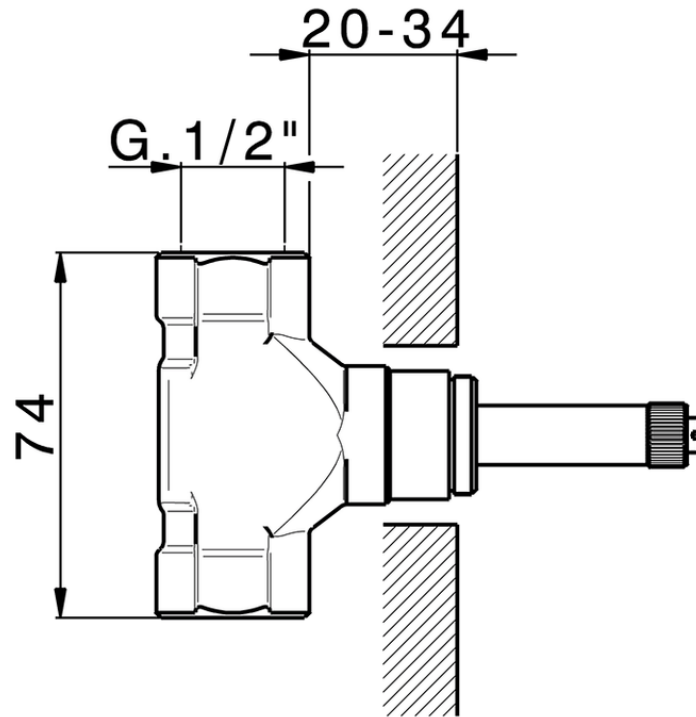

ZA003321

<https://es.cisal.it/parte-empotrada-llave-de-paso-1-2-empotrado-za003321>

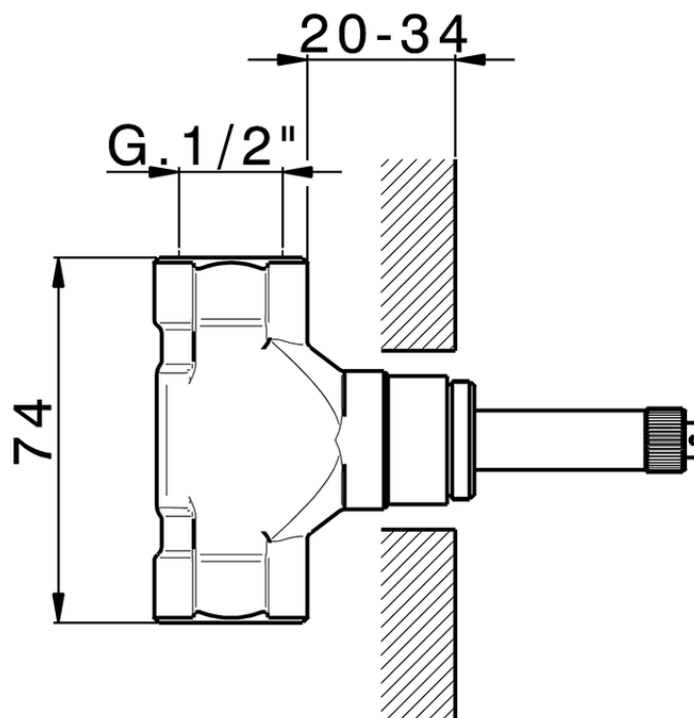

ZA003320

<https://es.cisal.it/parte-empotrada-llave-de-paso-1-2-empotrado-za003320>

2026-06-13