

## Parte externa llave de paso **CHERIE\_CF003310**

MODELO **CF003310**

Parte externa llave de paso, sin parte empotrada, para art. ZA003320 - ZA003321, ZA003310 - ZA003311



### ACABADOS DISPONIBLES

- 
**6T** 6T Cromo/Negro Mate
- 
**7C** 7C Oro/Negro Mate
- 
**7D** 7D Niquel Brillo/Negro Mate
- 
**7E** 7E Oro Rosa/Negro Mate

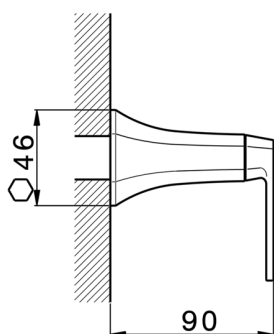

### CARACTERÍSTICAS

Instalación	<b>Empotrado</b>
Empotrado 4	<b>ZA003311</b>
	<b>ZA003310</b>
	<b>ZA003321</b>
	<b>ZA003320</b>



## Parte empotrada llave de paso 3/4" EMPOTRADO\_ZA003311

MODELO **ZA003311**

Parte empotrada llave de paso 3/4", apert. en sentido agujas del reloj

ACABADOS DISPONIBLES



**04** 04 Sin acabado

CARACTERÍSTICAS

Empotrado **1**

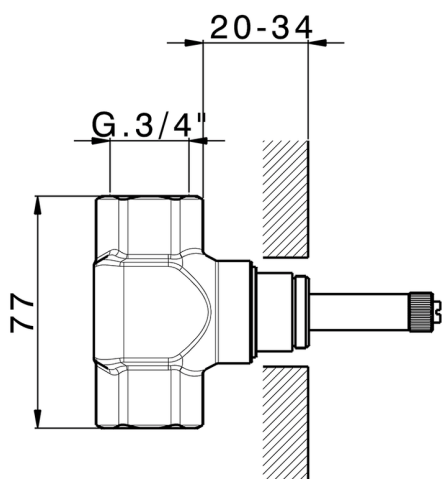

## Parte empotrada llave de paso 3/4" EMPOTRADO\_ZA003310

MODELO **ZA003310**

Parte empotrada llave de paso 3/4", Apert. sentido contrario agujas del reloj

ACABADOS DISPONIBLES



**04** 04 Sin acabado

CARACTERÍSTICAS

Empotrado **1**

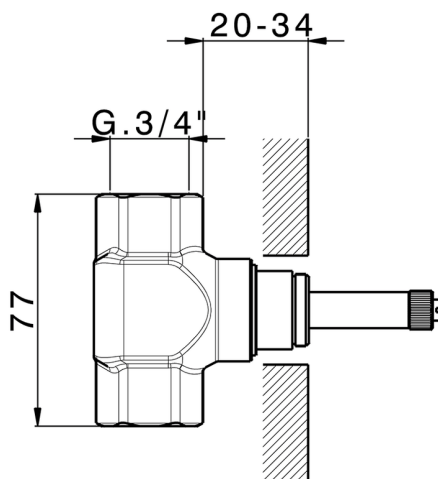

## Parte empotrada llave de paso 1/2" EMPOTRADO\_ZA003321

MODELO **ZA003321**

Parte empotrada llave de paso 1/2", apert.en sentido agujas del reloj

ACABADOS DISPONIBLES



**04** 04 Sin acabado

CARACTERÍSTICAS

Empotrado **1**

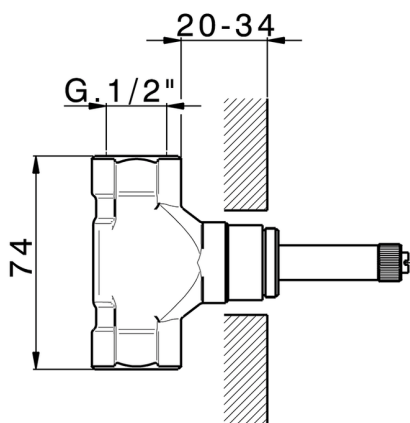

## Parte empotrada llave de paso 1/2" EMPOTRADO\_ZA003320

MODELO **ZA003320**

Parte empotrada llave de paso 1/2", apert. sentido contrario agujas del reloj

ACABADOS DISPONIBLES

 **04** 04 Sin acabado

CARACTERÍSTICAS

Empotrado **1**

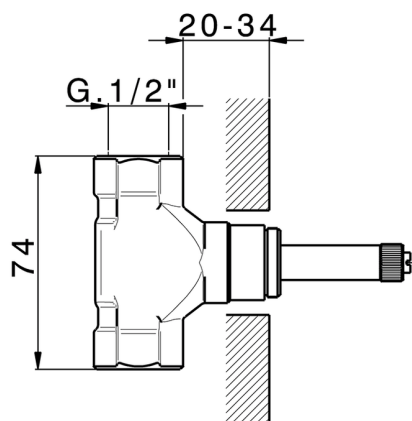

2026-06-14