

Lavabo monomando CLINIC_CL000512

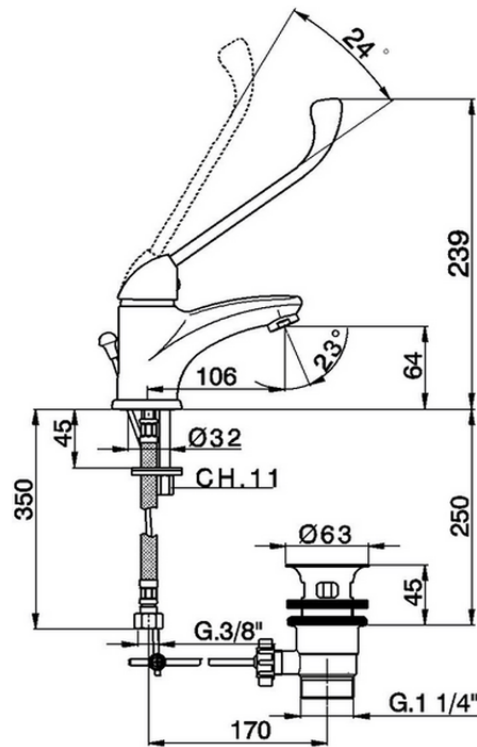

CL000512

<https://es.cisal.it/lavabo-monomando-clinic-cl000512>

2026-04-29