

Parte empotrada termostático ducha 2 salidas EMPOTRADO_ZA019340

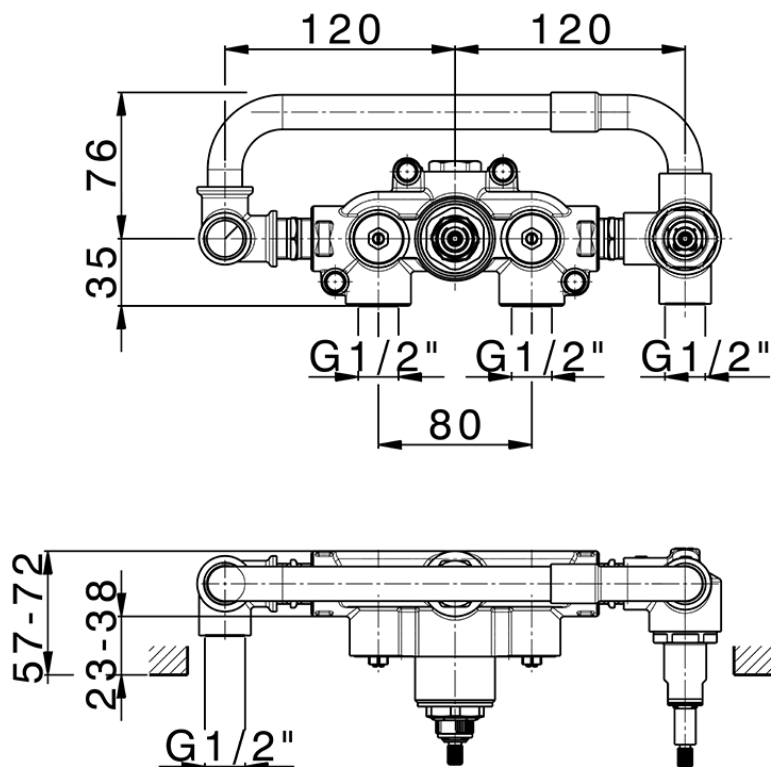

ZA019340

<https://es.cisal.it/parte-empotrada-termostatico-ducha-2-salidas-empotrado-za019340>

2026-05-01