

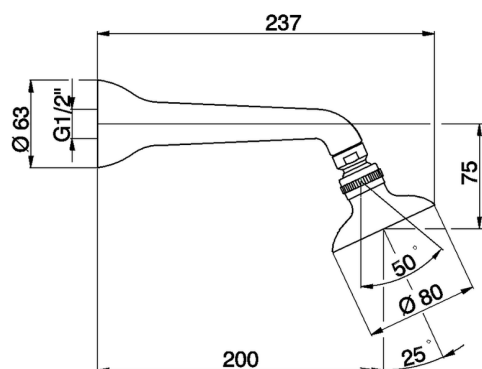





## Brazo ducha ARCANA COMPLEMENTOS \_AR001540



MODELO **AR001540**

Brazo ducha, L.200 mm

ACABADOS DISPONIBLES

-  **21** 21 Cromo
-  **24** 24 Oro
-  **26** 26 Cobre Viejo
-  **27** 27 Bronce Viejo
-  **2A** 2A Niquel Satinado Cepillado
-  **74** 74 Cromo/Oro

CARACTERÍSTICAS



2026-06-13