

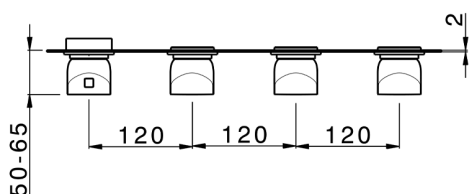

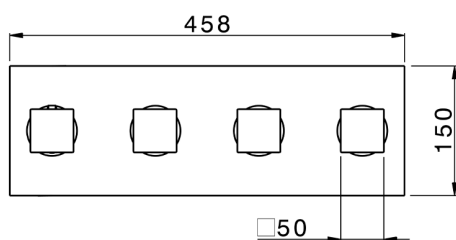

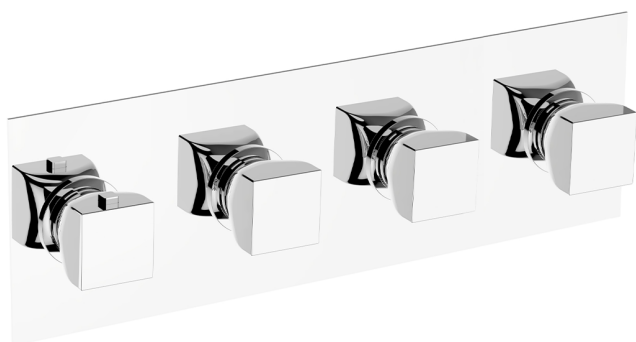





## Parte externa termostático ducha 3 funciones HI-RISE\_RI01R300



MODELO **RI01R300**

Parte externa termostático ducha 3 funciones, para art.ZA01R300

### ACABADOS DISPONIBLES

-  **21** 21 Cromo
-  **24** 24 Oro
-  **2F** 2F Niquel Cepillado
-  **2W** 2W Oro Cepillado
-  **40** 40 Negro Mate
-  **4Q** 4Q Blanco Mate
-  **5G** 5G Oro Rosa
-  **6V** 6V Blanco Mate/Niquel Cepillado
-  **6X** 6X Blanco Mate/Oro Cepillado
-  **7W** 7W Negro Mate/Oro Cepillado

### CARACTERÍSTICAS

Instalación

Empotrado 1

**Empotrado**

**ZA01R300**



### Termostático

El termostático Cisal es tu gestor personal del agua, ayudándote a manejar, controlar y ahorrar agua y energía.

## Parte empotrada termostático 3 funciones EMPOTRADO\_ZA01R300

MODELO **ZA01R300**

Parte empotrada termostático 3 funciones

ACABADOS DISPONIBLES

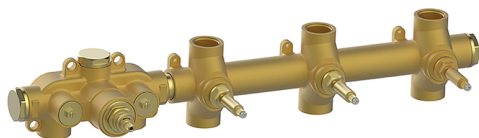

CARACTERÍSTICAS

Recambio Cartucho **23.51A.HF**

Empotrado **1**

**Cartucho Termostático HF**

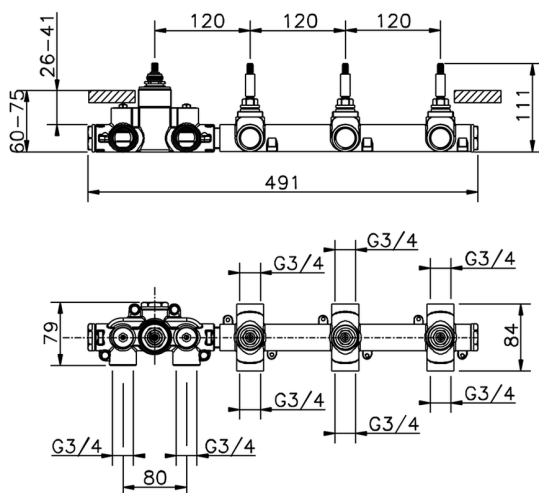

### Termostático

El termostático Cisal es tu gestor personal del agua, ayudándote a manejar, controlar y ahorrar agua y energía.



2026-06-14