

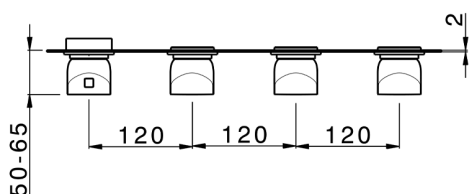

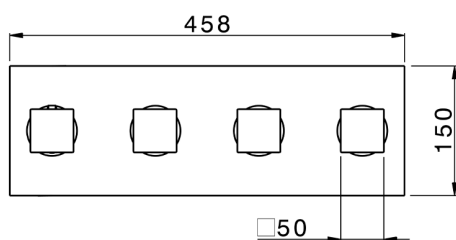

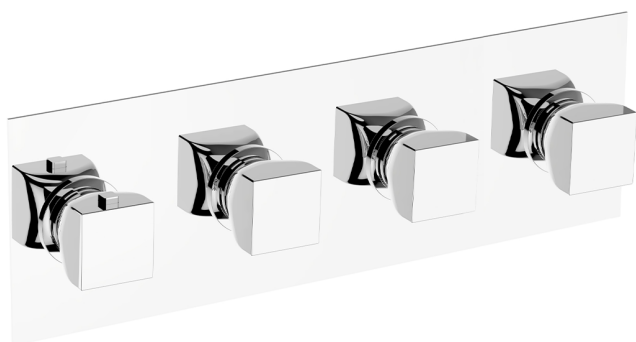





Parte externa termostático ducha 3 funciones HI-RISE_RI01R300



MODELO **RI01R300**

Parte externa termostático ducha 3 funciones, para art.ZA01R300

ACABADOS DISPONIBLES

-  **21** 21 Cromo
-  **24** 24 Oro
-  **2F** 2F Niquel Cepillado
-  **2W** 2W Oro Cepillado
-  **40** 40 Negro Mate
-  **4Q** 4Q Blanco Mate
-  **5G** 5G Oro Rosa
-  **6V** 6V Blanco Mate/Niquel Cepillado
-  **6X** 6X Blanco Mate/Oro Cepillado
-  **7W** 7W Negro Mate/Oro Cepillado

CARACTERÍSTICAS

Instalación

Empotrado 1

Empotrado

ZA01R300



Termostático

El termostático Cisal es tu gestor personal del agua, ayudándote a manejar, controlar y ahorrar agua y energía.

Parte empotrada termostático 3 funciones EMPOTRADO_ZA01R300

MODELO **ZA01R300**

Parte empotrada termostático 3 funciones

ACABADOS DISPONIBLES

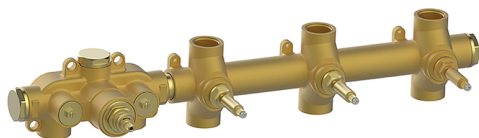

CARACTERÍSTICAS

Recambio Cartucho **23.51A.HF**

Empotrado **1**

Cartucho Termostático HF

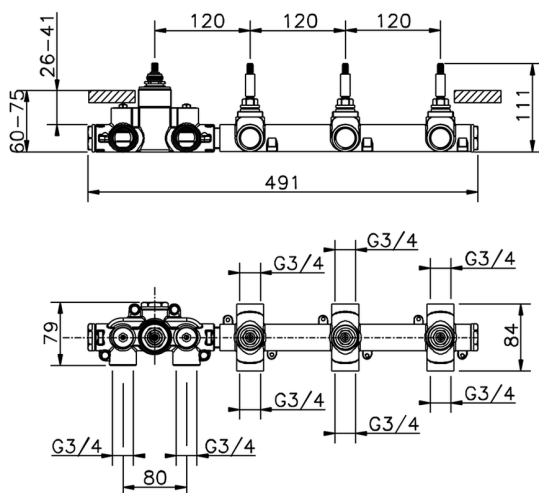

Termostático

El termostático Cisal es tu gestor personal del agua, ayudándote a manejar, controlar y ahorrar agua y energía.



2026-04-30