

## Jabonera ARCANA COMPLEMENTOS \_AR090490

MODELO **AR090490**

Jabonera, de cerámica



ACABADOS DISPONIBLES

- 
**21** 21 Cromo
- 
**24** 24 Oro
- 
**26** 26 Cobre Viejo
- 
**27** 27 Bronce Viejo
- 
**2A** 2A Niquel Satinado Cepillado
- 
**74** 74 Cromo/Oro

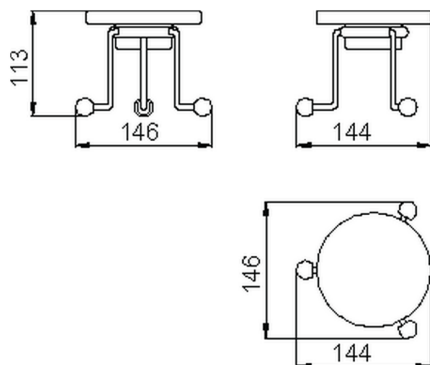

CARACTERÍSTICAS



2026-06-19