





Bañera termostática LINEAVIVA_LVT21010

MODELO **LVT21010**

Bañera termostática, sin conjunto ducha, conexión para flexible 1/2" M

ACABADOS DISPONIBLES

-  **21** 21 Cromo
-  **2B** 2B Níquel Brillo
-  **2F** 2F Níquel Cepillado
-  **40** 40 Negro Mate
-  **4Q** 4Q Blanco Mate

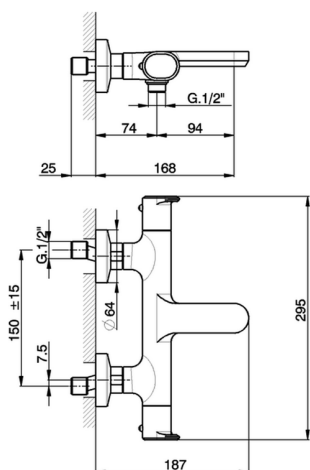

CARACTERÍSTICAS

Recambio Cartucho **ZZ96551000**

Cartucho Termostático TMX 25



DeviaStop

La tecnología Cisal DeviaStop le permite ajustar el caudal de agua y dirigirla hacia la salida elegida (rociador superior, ducha de mano, etc.).



SafeTouch

El sistema Cisal SafeTouch mantiene el cuerpo de la grifería frío al cuerpo durante el uso.



Termostático

El termostático Cisal es tu gestor personal del agua, ayudándote a manejar, controlar y ahorrar agua y energía.



Bañera termostática LINEAVIVA_LVT21010

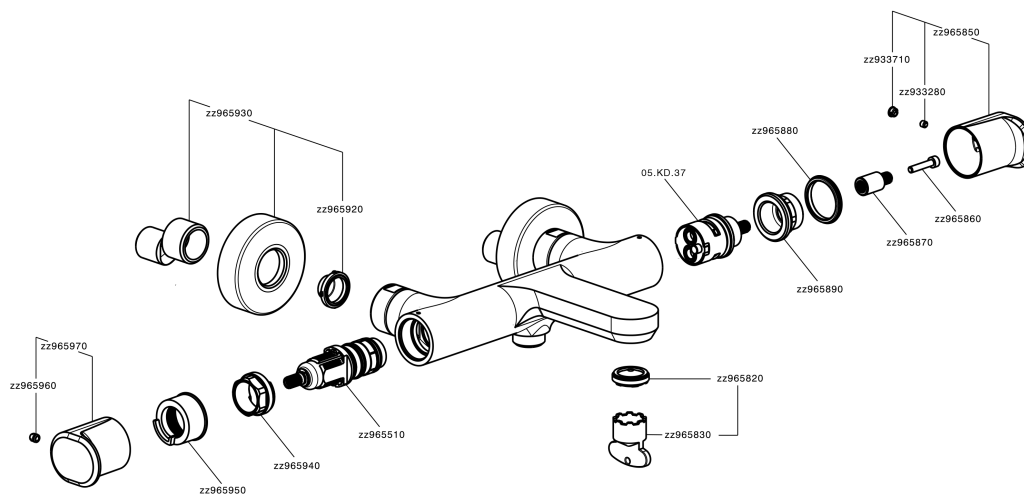

LVT21010

<https://es.cisal.it/banera-termostatica-lineaviva-lvt21010>

2026-03-15