

Parte empotrada llave de paso 1/2" EMPOTRADO_ZA003320

MODELO **ZA003320**

Parte empotrada llave de paso 1/2", apert. sentido contrario agujas del reloj

ACABADOS DISPONIBLES



04 04 Sin acabado

CARACTERÍSTICAS

Empotrado **1**

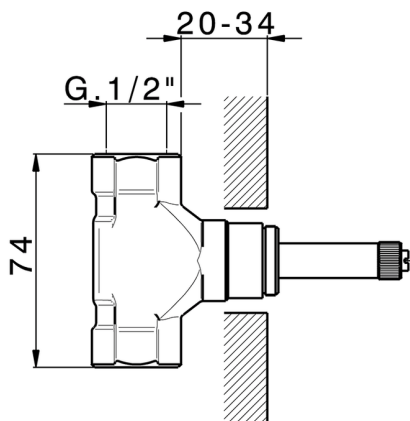

2026-06-14