

Parte externa termostático ducha emp. 2 salidas HI-RISE_RI019100

RI019100

<https://es.cisal.it/parte-externa-termostatico-ducha-emp-2-salidas-hi-rise-ri019100>

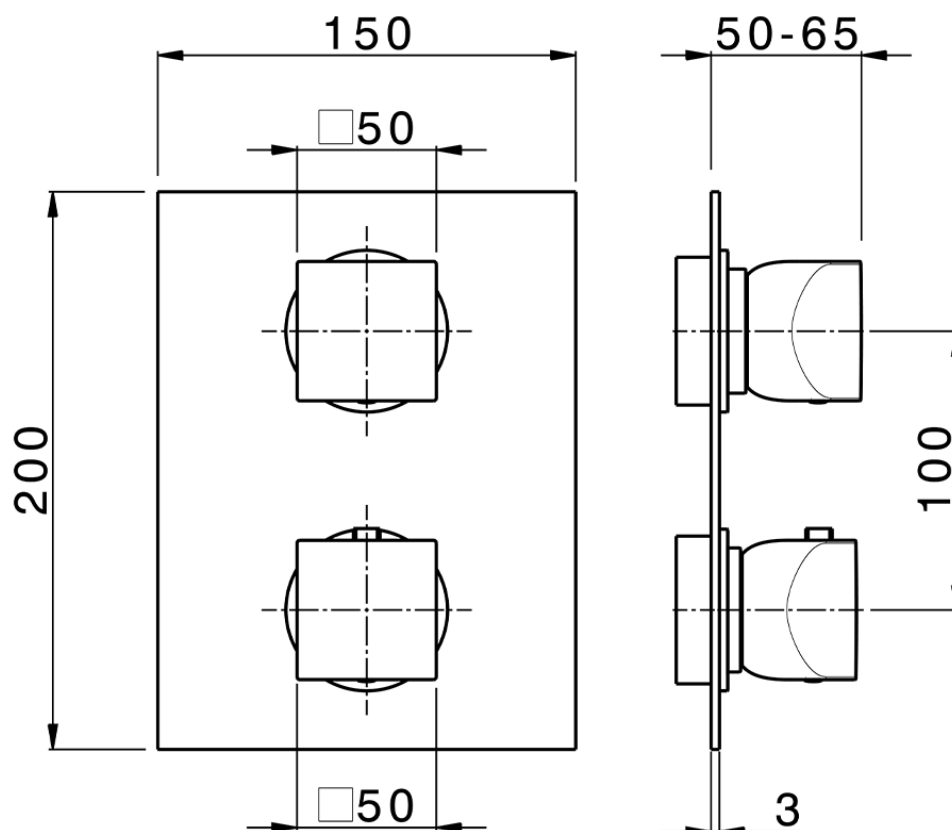
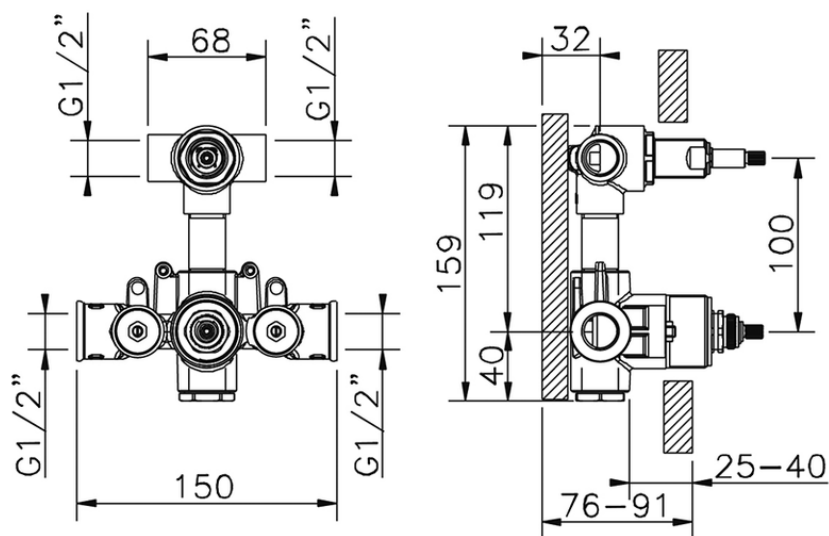

ZA019101

<https://es.cisal.it/parte-empotrada-termostatico-ducha-2-salidas-empotrado-za019101>

2024-12-22