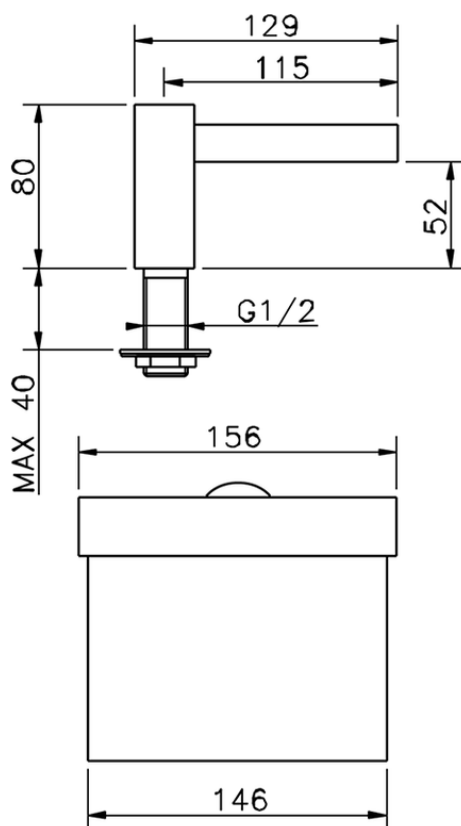

**Caño de erogación COMPLEMENTOS\_ZA002620**

ZA002620

<https://es.cisal.it/cano-de-erogacion-complementos-za002620>

2025-01-05