

Parte externa termostático ducha 2 funciones WELLNESS_X100R200

MODELO **X100R200**

Parte externa termostático ducha 2 funciones, para art.ZA00R200 instalación horizontal, para art.ZA00V200 instalación vertical, Inox AISI 316L

ACABADOS DISPONIBLES

-  **5H** 5H Dark Brass Brushed
-  **5L** 5L Brushed Black Titanium
-  **5N** 5N Oro Rosa Cepillado
-  **D1** D1 Inox Cepillado

CARACTERÍSTICAS

Instalación	Empotrado
Empotrado 2	ZA00V200
	ZA00R200

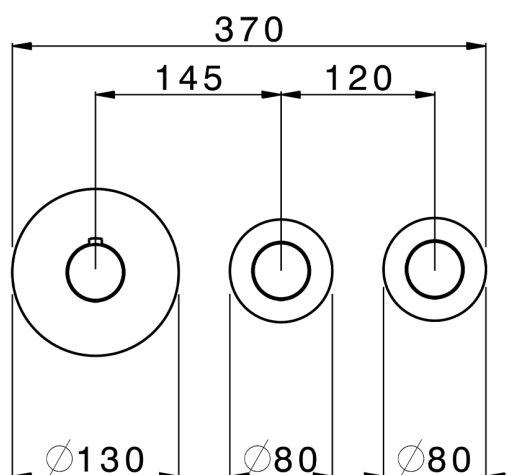
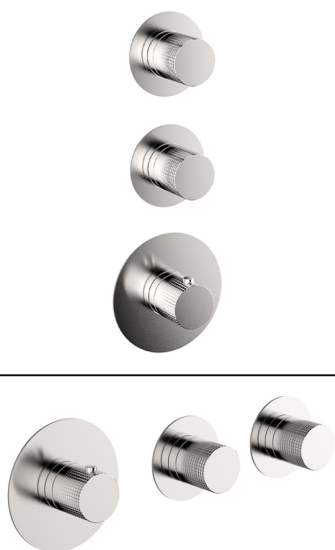

Termostático

El termostático Cisal es tu gestor personal del agua, ayudándote a manejar, controlar y ahorrar agua y energía.



Parte externa termostático ducha 2 funciones WELLNESS_X100R200

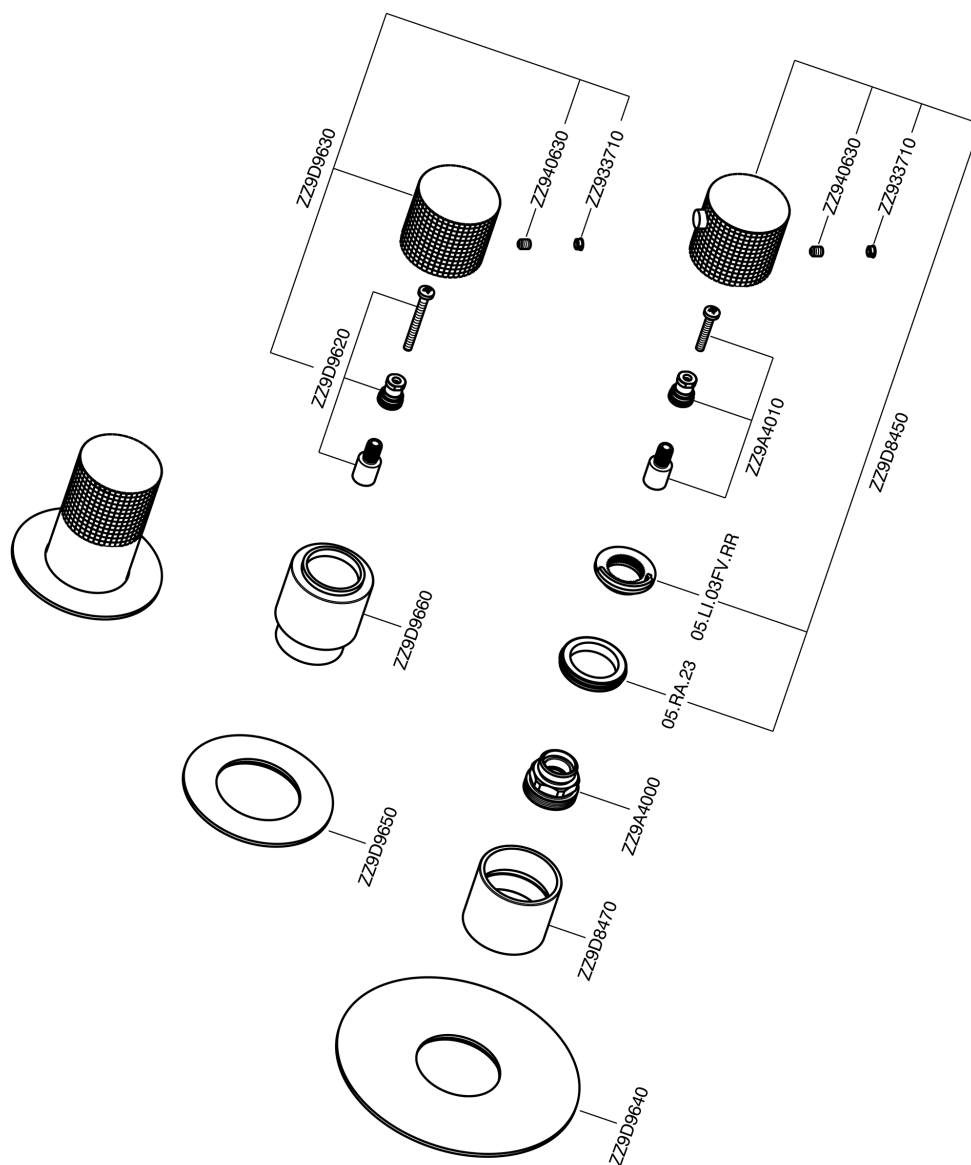

X100R200

<https://es.cisal.it/parte-externa-termostatico-ducha-2-funciones-wellnessx100r200>

Parte empotrada termostático ducha 2 funciones EMPOTRADO_ZA00V200

MODELO **ZA00V200**

Parte empotrada termostático ducha 2 funciones

ACABADOS DISPONIBLES



CARACTERÍSTICAS

Recambio Cartucho **23.51A.HF**

Empotrado **1**

Cartucho Termostático HF

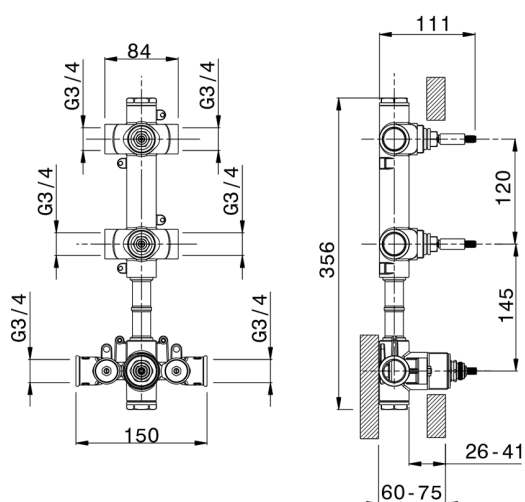

Termostático

El termostático Cisal es tu gestor personal del agua, ayudándote a manejar, controlar y ahorrar agua y energía.



Parte empotrada termostático ducha 2 funciones EMPOTRADO_ZA00R200

MODELO **ZA00R200**

Parte empotrada termostático ducha 2 funciones

ACABADOS DISPONIBLES



CARACTERÍSTICAS

Recambio Cartucho **23.51A.HF**

Empotrado **1**

Cartucho Termostático HF

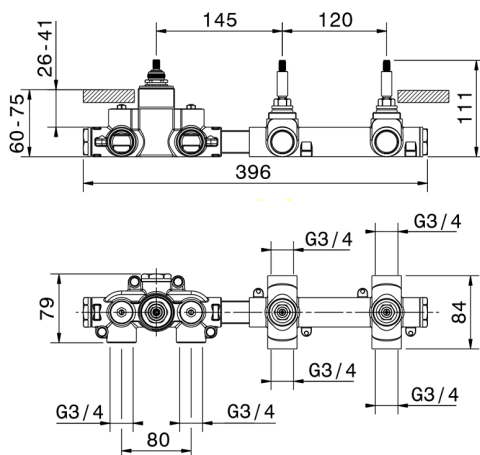

Termostático

El termostático Cisal es tu gestor personal del agua, ayudándote a manejar, controlar y ahorrar agua y energía.



2024-09-16