

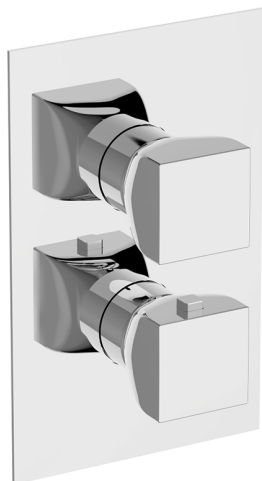









## Conjunto Termostático para One-Box ONE BOX\_RI0BT030



MODELO **RI0BT030**

Conjunto Termostático para One-Box, con devistop  
1-2-3 salidas, profundidad mínima de instalación 67  
mm, sin parte empotrada, para  
art.ZA00B030-ZA00B031

### ACABADOS DISPONIBLES

-  **21** 21 Cromo
-  **24** 24 Oro
-  **2F** 2F Niquel Cepillado
-  **2W** 2W Oro Cepillado
-  **40** 40 Negro Mate
-  **4Q** 4Q Blanco Mate
-  **5G** 5G Oro Rosa
-  **6V** 6V Blanco Mate/Niquel Cepillado
-  **6X** 6X Blanco Mate/Oro Cepillado
-  **7W** 7W Negro Mate/Oro Cepillado

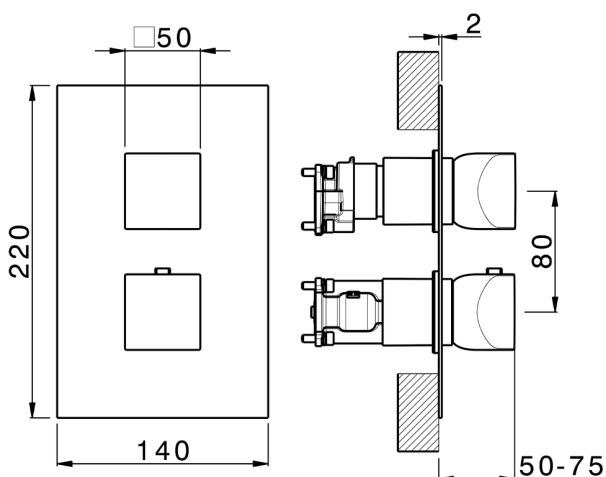

### CARACTERÍSTICAS

Recambio Cartucho **24.04A.PP**

**Cartucho Termostático Plus P 8X20**

Instalación **Empotrado**



### DeviaStop

La tecnología Cisa DeviaStop le permite ajustar el caudal de agua y dirigirla hacia la salida elegida (rociador superior, ducha de mano, etc.).



### Termostático

El termostático Cisa es tu gestor personal del agua, ayudándote a manejar, controlar y ahorrar agua y energía.



## One-Box Universal para empotrado ONE BOX\_ZA00B031



MODELO **ZA00B031**

One-Box Universal para empotrado, para termostático o monomando 1,2 o 3 salidas, sin parte externa, con silenciadores, con junta para sellado

ACABADOS DISPONIBLES



CARACTERÍSTICAS

Empotrado **1**



### Termostático

El termostático Cisal es tu gestor personal del agua, ayudándote a manejar, controlar y ahorrar agua y energía.



## One-Box Universal para empotrado ONE BOX\_ZA00B030



MODELO **ZA00B030**

One-Box Universal para empotrado, para termostático o monomando 1,2 o 3 salidas, sin parte externa, sin silenciadores, con junta para sellado

ACABADOS DISPONIBLES

 **04** 04 Sin acabado

CARACTERÍSTICAS

Empotrado **1**



### Termostático

El termostático Cisal es tu gestor personal del agua, ayudándote a manejar, controlar y ahorrar agua y energía.



2026-05-01