

Alargador +15 mm COMPLEMENTOS_ZA000470

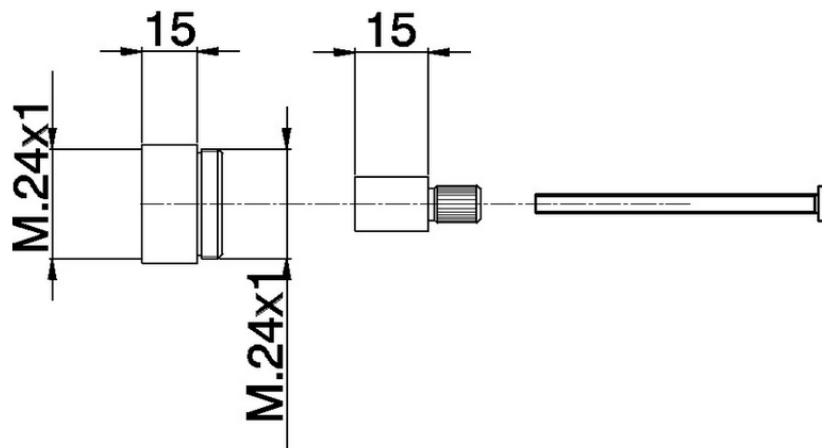

ZA000470

<https://es.cisal.it/alargador-15-mm-complementos-za000470>

2026-06-17