

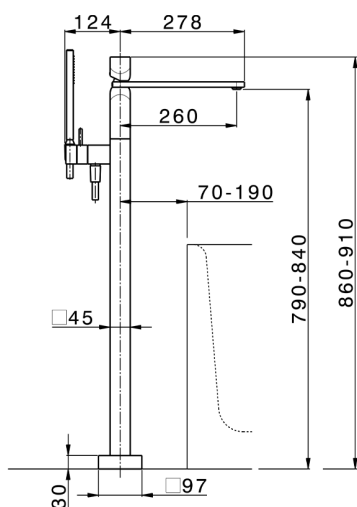

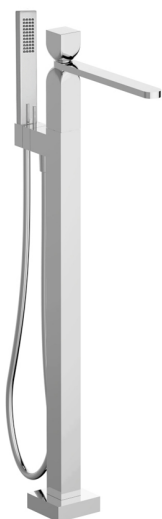







## Parte externa monomando bañera de suelo HI-RISE\_RI014204



MODELO **RI014204**

Parte externa monomando bañera de suelo, soporte duchita sobre columna, duchita una función minimalista 35x15 mm Latón, flexible liso SUPREME 150 cm

### ACABADOS DISPONIBLES

-  **21** 21 Cromo
-  **24** 24 Oro
-  **2F** 2F Niquel Cepillado
-  **2W** 2W Oro Cepillado
-  **40** 40 Negro Mate
-  **4Q** 4Q Blanco Mate
-  **5G** 5G Oro Rosa
-  **6V** 6V Blanco Mate/Niquel Cepillado
-  **6X** 6X Blanco Mate/Oro Cepillado
-  **7W** 7W Negro Mate/Oro Cepillado

### CARACTERÍSTICAS

Recambio Cartucho **ZZ96550000**

**Cartucho Monomando 25 mm**

Instalación **Empotrado**

Empotrado 1

**ZA004510**



## Parte empotrada monomando free-standing EMPOTRADO\_ZA004510

MODELO **ZA004510**

Parte empotrada monomando free-standing

ACABADOS DISPONIBLES

 **04** 04 Sin acabado

CARACTERÍSTICAS

Empotrado **1**

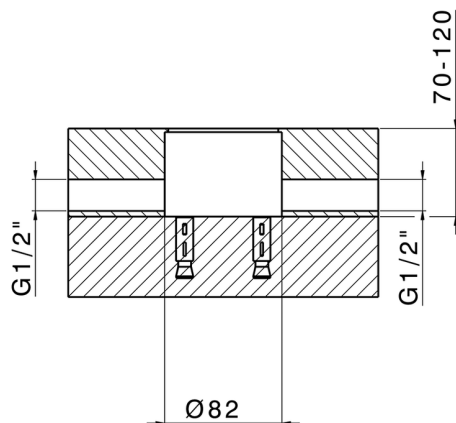

2026-04-30