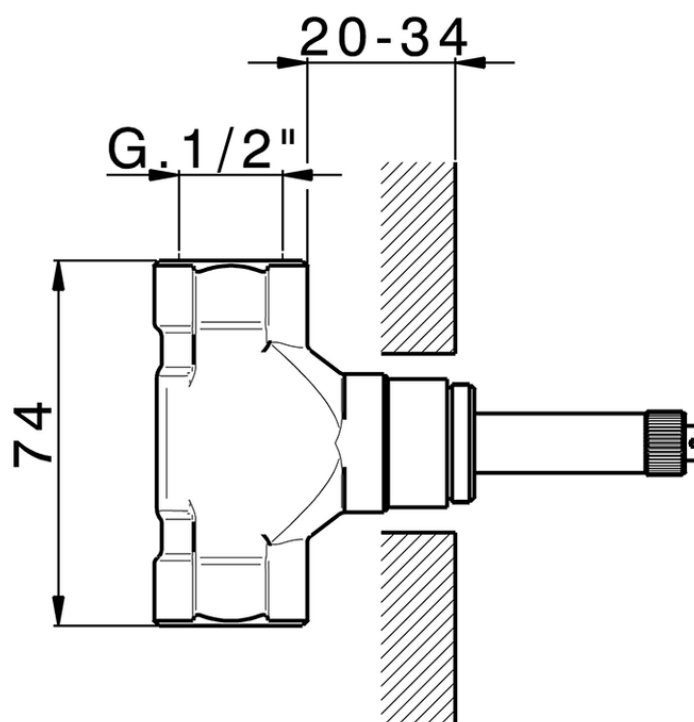

Parte empotrada llave de paso 1/2" EMPOTRADO_ZA003321

ZA003321

<https://es.cisal.it/parte-empotrada-llave-de-paso-1-2-empotrado-za003321>

2026-04-29