

Parte externa termostático ducha emp. 3 salidas SLIM_SM018200

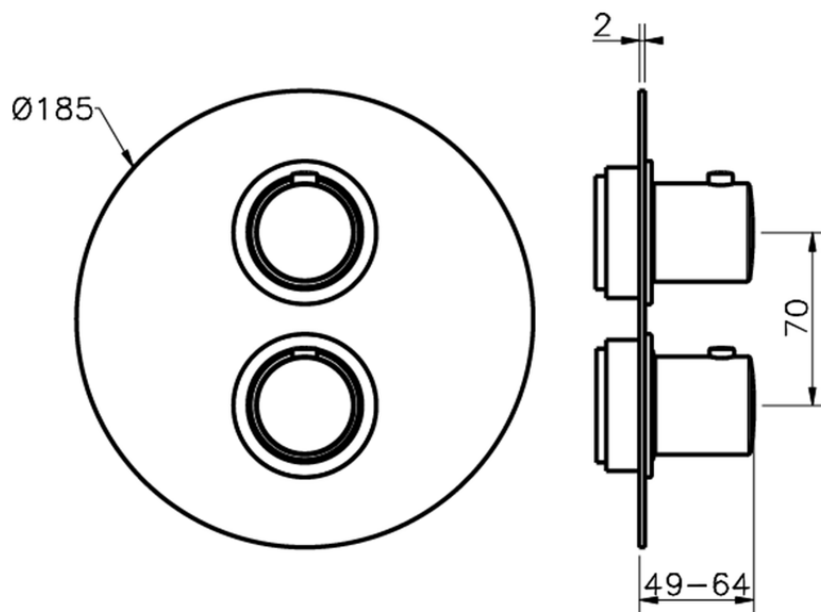

SM018200

<https://es.cisal.it/parte-externa-termostatico-ducha-emp-3-salidas-slim-sm018200>



Piastra/Plate/Plaque/Platte/Placa

2-3mm: XX 25-40 YY 76-91

10 mm: XX 16-31 YY 65-80

ZA018201

<https://es.cisal.it/parte-empotrada-termostatico-ducha-3-salidas-empotrado-za018201>

2026-05-03