

Conjunto Monomando para One-Box ROADSTER ACCENT_RA0BM010

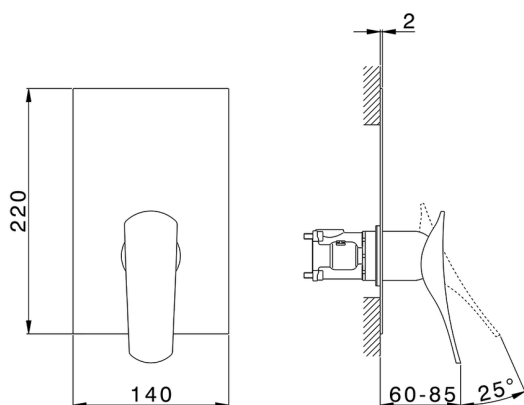

MODELO **RA0BM010**

Conjunto Monomando para One-Box, 1 salida, profundidad mínima de instalación 67 mm, sin parte empotrada, para art. ZA00B030-ZA00B031

ACABADOS DISPONIBLES

-  **21** 21 Cromo
-  **2B** 2B Niquel Brillo
-  **2F** 2F Niquel Cepillado
-  **2Q** 2Q Black Titanium
-  **40** 40 Negro Mate
-  **4Q** 4Q Blanco Mate

CARACTERÍSTICAS

Recambio Cartucho **ZZ97179000**

Cartucho Monomando 35 mm

Instalación **Empotrado**

Empotrado 2 **ZA00B031**

ZA00B030



Conjunto Monomando para One-Box ROADSTER ACCENT_RA0BM010

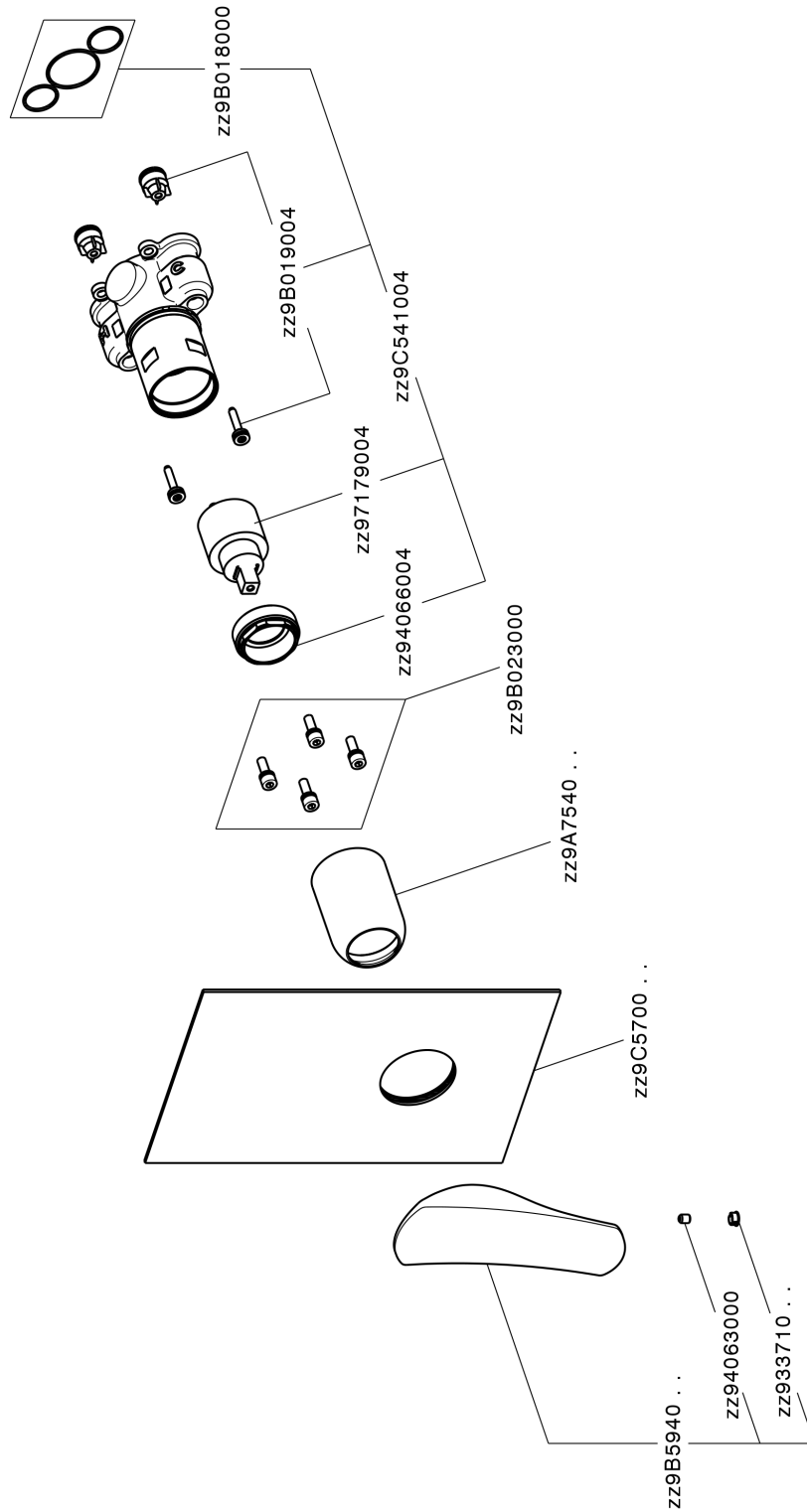

RA0BM010

<https://es.cisal.it/conjunto-monomando-para-one-box-roadster-accent-ra0bm010>

One-Box Universal para empotrado ONE BOX_ZA00B031

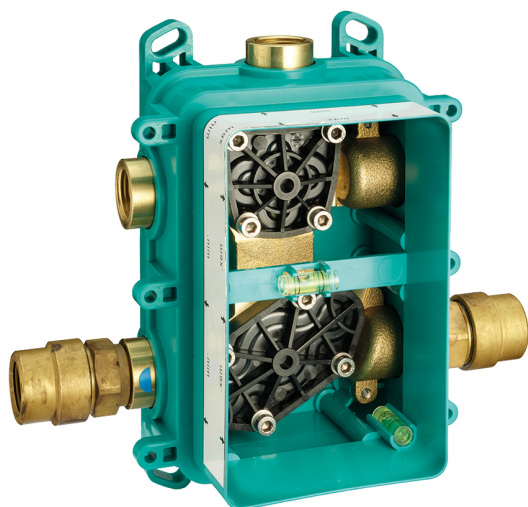

MODELO **ZA00B031**

One-Box Universal para empotrado, para termostático o monomando 1,2 o 3 salidas, sin parte externa, con silenciadores, con junta para sellado

ACABADOS DISPONIBLES

 **04** 04 Sin acabado

CARACTERÍSTICAS

Empotrado **1**



Termostático

El termostático Cisal es tu gestor personal del agua, ayudándote a manejar, controlar y ahorrar agua y energía.



One-Box Universal para empotrado ONE BOX_ZA00B030



MODELO **ZA00B030**

One-Box Universal para empotrado, para termostático o monomando 1,2 o 3 salidas, sin parte externa, sin silenciadores, con junta para sellado

ACABADOS DISPONIBLES

 **04** 04 Sin acabado

CARACTERÍSTICAS

Empotrado **1**



Termostático

El termostático Cisal es tu gestor personal del agua, ayudándote a manejar, controlar y ahorrar agua y energía.



2025-01-15