

Parte externa termostático ducha emp. 1 salida SMOOTH X32_X3007300

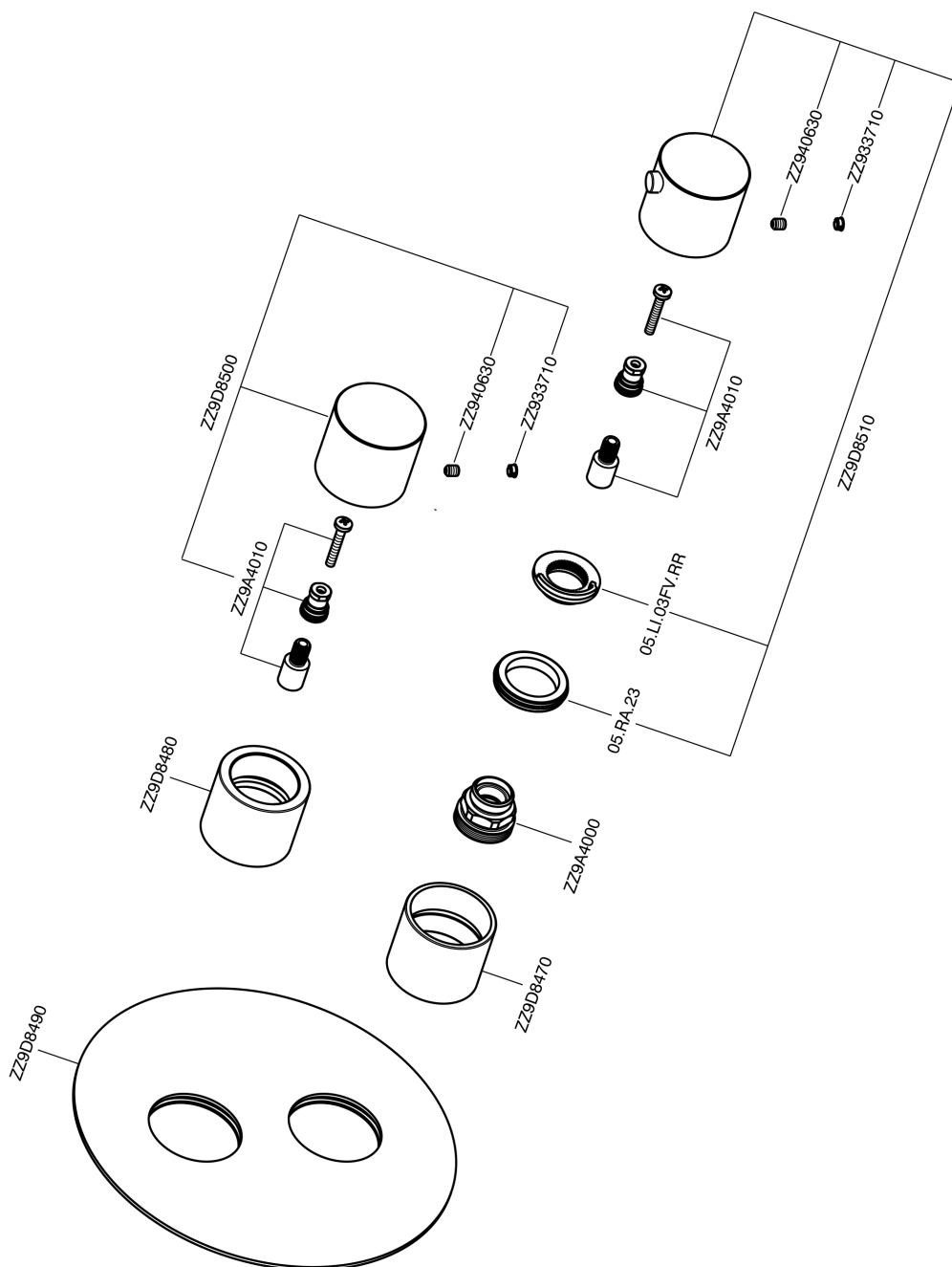

X3007300

<https://es.cisal.it/parte-externa-termostatico-ducha-emp-1-salida-smooth-x32x3007300>

Parte empotrada termostático ducha 1 salida EMPOTRADO_ZA007301

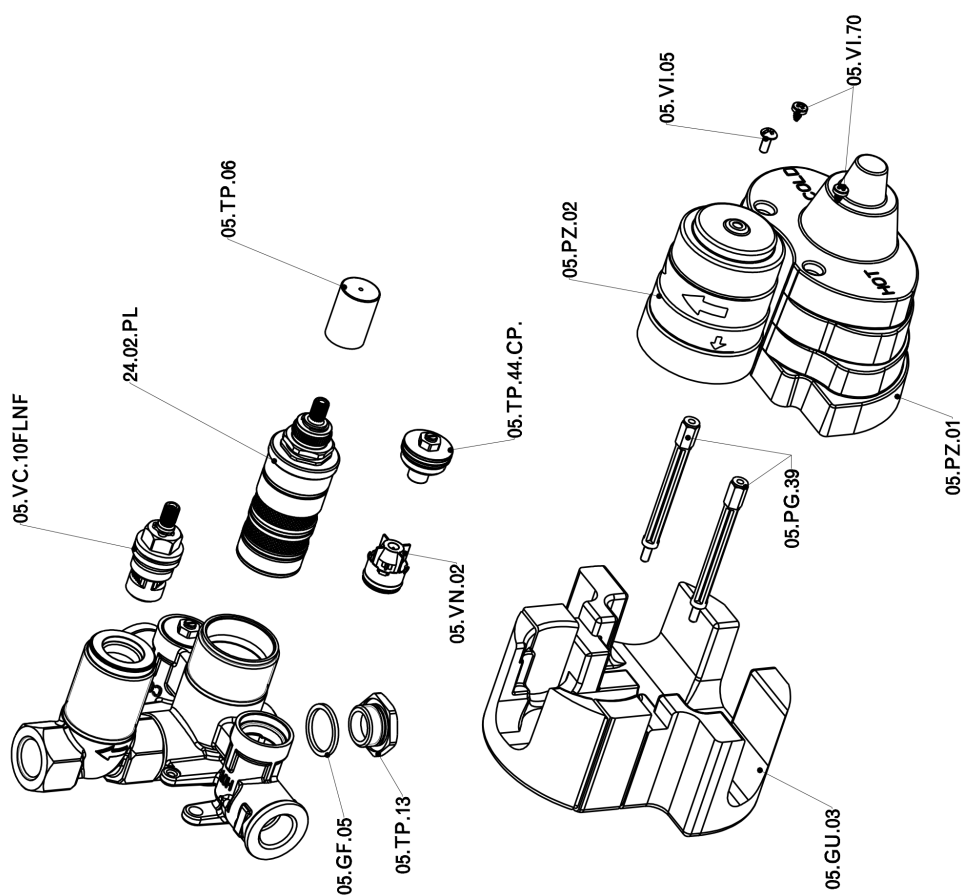

ZA007301

<https://es.cisal.it/parte-empotrada-termostatico-ducha-1-salida-empotradoza007301>

2024-09-19