





Parte externa termostático ducha 2 funciones WELLNESS_VI01R200

MODELO **VI01R200**

Parte externa termostático ducha 2 funciones, para art.ZA01R200

ACABADOS DISPONIBLES

-  **21** 21 Cromo
-  **2Q** 2Q Black Titanium
-  **40** 40 Negro Mate
-  **4Q** 4Q Blanco Mate

CARACTERÍSTICAS

Instalación **Empotrado**
Empotrado 1 **ZA01R200**

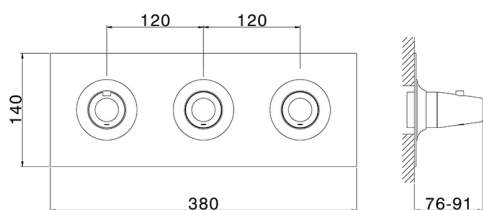

Termostático

El termostático Cisal es tu gestor personal del agua, ayudándote a manejar, controlar y ahorrar agua y energía.



Parte esterna termostático ducha 2 funciones WELLNESS_VI01R200

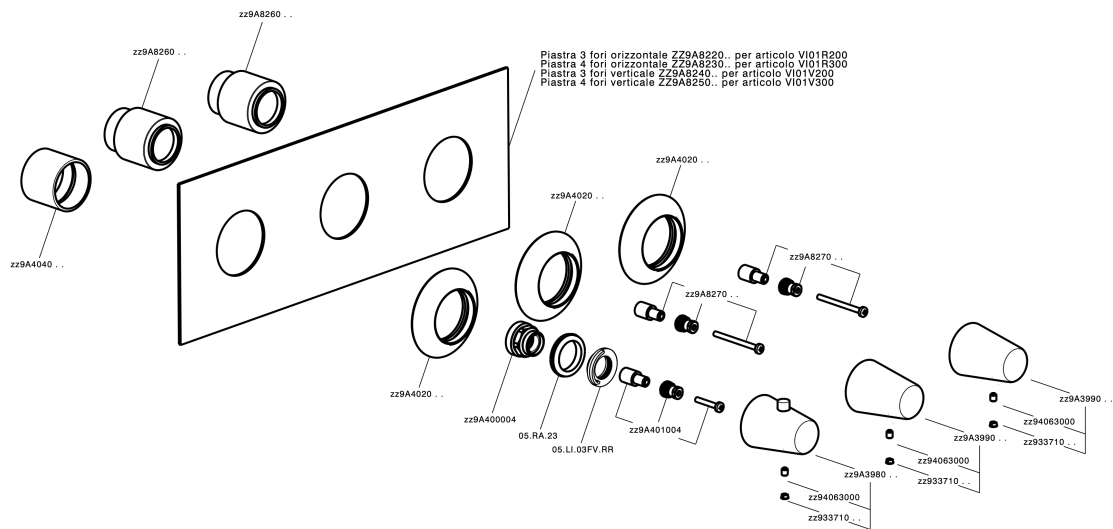

VI01R200

<https://es.cisal.it/parte-externa-termostatico-ducha-2-funciones-wellness-vi01r200>

Parte empotrada termostático ducha 2 funciones EMPOTRADO_ZA01R200

MODELO **ZA01R200**

Parte empotrada termostático ducha 2 funciones

ACABADOS DISPONIBLES

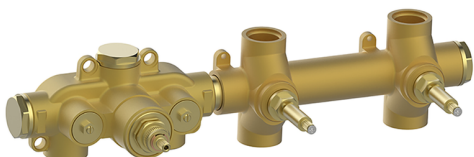

CARACTERÍSTICAS

Recambio Cartucho **23.51A.HF**

Empotrado **1**

Cartucho Termostático HF

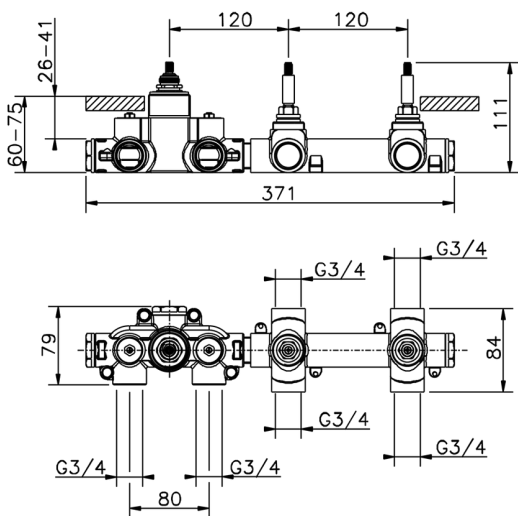

Termostático

El termostático Cisal es tu gestor personal del agua, ayudándote a manejar, controlar y ahorrar agua y energía.



2024-11-23